

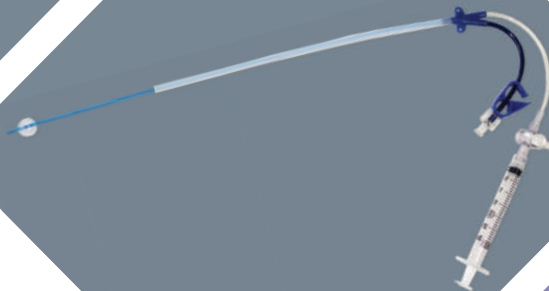

Product Catalog

Innovative Products for Women's Health





Company Profile

Founded in 1975, MedGyn manufactures and distributes medical devices for women's healthcare including single use devices, high-quality instruments and equipment for Obstetrics and Gynecology professionals. MedGyn collaborates with physicians and clinical staff worldwide to ensure our products meet and exceed their expectations. With focus on our corporate values, MedGyn has flourished as a leading provider of medical devices globally.

OUR MISSION

Trusted global provider of women's health products

OUR VISION

To advance women's health worldwide through innovative solutions

OUR VALUES

Commitment to the highest level of service for our customers.

Collaboration with our suppliers, partners, and teammates.

Growth together as an organization to make an imprint on women's health.

Innovation new products and services to meet our customers' needs.

Table of Contents

Colposcopy	1
Cryotherapy	5
Thermal Ablation	7
Electrosurgery	8
Obstetrics	11
Vacuum Pumps	14
Gynecological Kits	15
Single-Use Gynecology/Oncology	20
Single-Use Infertility	27
Single-Use Family Planning	32
Single-Use General Gynecology	37
Single-Use Obstetrics	42
Pessaries	44
Speculums	50
LLETZ Instruments	55
Tenaculums	59
Biopsy Punches	63
Dilators	71
Metal Curettes	75
Forceps	78
Long-Reach Instruments	86
Hysterectomy Instruments	88
Scissors	89
Needle Holders	92
Miscellaneous	93



GENERAL
GYNECOLOGY



GYNECOLOGY
ONCOLOGY



INFERTILITY



OBSTETRICS



UROGYNECOLOGY



FAMILY
PLANNING

MedGyn AL-106 HD™ Digital Video Colposcopes

Different from the traditional optical colposcopes, the AL-106HD™ is a digital colposcope with an LED light source for ultra-bright visualization and a long life cycle. Its unique optical precision and multiple green light filters ensure the highest quality images and improved visualization of blood vessels.

- High-resolution: 3.2M px for AL-106HD
- LED light
- 1-40x magnification
- Ultra-fast auto focus and manual focus option
- Video and image freeze
- Green light filters



010466-HD



010466SA-HD

- 010466-HD MedGyn AL-106 High Definition Digital Video Colposcope*
- 010466SA-HD MedGyn AL-106 High Definition Digital Video Colposcope with Swing Arm*
- 010010 Colposcope Monitor (Used for AL-101, AL-102, AL-401, AL-105, AL-106)*
- 010490 Colposcope Monitor Stand (Adjustable with Rolling Base)

*Monitor Sold Separately

MedGyn AL-106B Digital Video Colposcope

The MedGyn AL-106B™ is a more affordable option to the AL-106 HD.

- Battery operated and wireless
- High-resolution of 440K pixels
- LED light
- 1-54x magnification
- Ultra-fast auto focus and manual focus option
- Video and image freeze
- Green light filters

010469 MedGyn AL-106B Digital Video Colposcope
*Monitor Sold Separately



MedGyn Image & Data Management Software

Designed for use with our AL-106 series of colposcopes, MedGyn's Image & Data Management Software captures and manages colposcopy images in a self-contained patient record. The user-friendly software includes numerous templates and is easily customizable to your clinic's requirements. The software automatically creates a variety of reports which can include colposcopy images.

- Image annotation and measurement
- Full video capture
- Statistical analysis
- Complete system security, internal password protected
- Includes capture card, security key, and foot switch

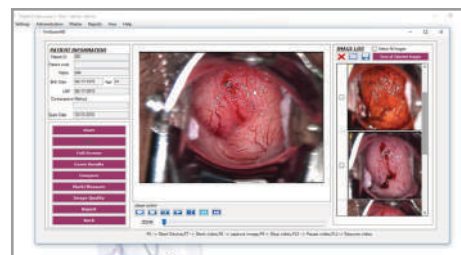
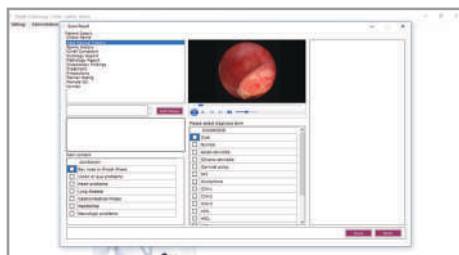

010477 MedGyn Image and Data Management Software

010476 MedGyn Image and Data Management Software with Laptop (monitor not included)

010475 MedGyn Image and Data Management Software with Laptop (monitor Included)

MedGyn AL-105 and AL-105Z Colposcopes

Traditional optical colposcopes compatible the the MedGyn Image & Data Management Software.

- Five-step magnification 3x, 4x, 7x, 11x, 17x
- LED light source with continuous adjustment
- High-contrast images with excellent stereoscopic effect
- Great depth of field
- Green filters



010500



010505

010500 MedGyn AL-105 Colposcope

010505 MedGyn AL-105Z Colposcope with Swing Arm

AL-105 Accessories

010514 AL-105 Beam Splitter/
Adapter Combined (Single
Port)



090025 Power Cord #209-000- UK



090026 Power Cord #199-000-
Europe



090027 Power Cord #364-010-
Italy



090028 Power Cord #364-010-
South Africa



010515 AL-105 Beam Splitter (Dual Port)

010516 AL-105 Adapter for CCD Camera

010050 AL-105 CCD Camera

010051 AL-105 HDMI CCD Camera

MedGyn AL-101 Colposcope

MedGyn's classic stereoscopic colposcope AL-101 is the industry standard. This model combines high-quality lens systems with easy maneuverability at an attractive price.

- 1-step magnification: 16x
- Crystal clear image
- 12.5x eyepieces, 1 fixed and 1 moveable
- Green filter
- Adjustable stand

010199 MedGyn AL-101 Colposcope



MedGyn Colposcopy Instrument Set

All the instruments you need for a thorough colposcopic examination.

- Tischler Biopsy Punch
- Endocervical Speculum
- Graves Speculum
- Endocervical Curette
- Emmet Hook

030350 MedGyn Colposcopy Instrument Set



MedGyn MGC-200 Cryotherapy System

The MedGyn Cryotherapy System is designed by physicians and engineered by cryogenic experts to ensure safety, performance, and convenience. The 3-position single trigger delivers optimal cryosurgical temperatures with Nitrous Oxide (N₂O) or Carbon Dioxide (CO₂) gas. The system has standard-specific adaptors and a wide variety of autoclavable tips available.

- Single-hand control with 3 settings: freeze, off, and defrost
- Instant defrost
- Change tips without shutting off the gas
- Built-in regulators control pressure at tip for added safety and gas economy

019000 MedGyn Cryotherapy System
MGC-200 (tips not included)



MedGyn Cryotherapy Tips

Safe, interchangeable, autoclavable tips are made from a conductive gold alloy, resulting in very rapid freeze and defrost capabilities. Designed to allow for change-out without the need to shut off gas flow, reducing risk of blown "O" ring.



019002/2507 Cryotherapy Tip GT-2507
Endo/Exocervical, Large



019002/0800 Cryotherapy Tip GT-0800
Endocervical, Round



019002/2500 Cryotherapy Tip Tip
GT-2500 Exocervical, 25mm Flat



019002/0519 Cryotherapy Tip GT-0519
Endocervical, Nulliparous



019002/1910 Cryotherapy Tip Tip
GT-1910 Endo/Exocervical, Small



019002/0507 Cryotherapy Tip GT-0507
Skin Lesion, 5mm Diam, 45° angle



019002/1905 Cryotherapy Tip GT-1905
Exocervical, Convex (19mm X 5mm)



019002/0219 Cryotherapy Tip GT-0219
Micro, 2mm Diam



019002/1900 Cryotherapy Tip GT-1900
Exocervical, 19mm Flat



019002/0832 Cryotherapy Tip GT-0832
Anorectal



019002/0811 Cryotherapy Tip GT-0811
Skin Lesion, 8mm Diam, 45° angle



019019

Cryotherapy Equipment & Accessories

019001 Cart for Cylinder, 20lb



019003 "O" Ring for Cryo System (3/pack)

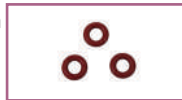

019008 French Adapter for CO2



019009 German Adapter for CO2



019010 British Adapter for CO2



019011 British Adapter for N2O



019012 German Adapter for N2O



019013 US Adapter for N2O (20lb)



019014 US Adapter for CO2 (20lb)



019015 Chinese Adapter for CO2



019016 French for N2O



019017 US Adapter for N2O (6lb)



019018 US Adapter for CO2 (6lb)



019019 Carrying Case for Cryotherapy System



019020 Protective Cap for Cryotherapy System



019021 Rubber Plug 6448K92 for MedGyn Cryo Tip



019030 450 Purifier Housing with 1/4 npt Male Thread Adapter



019022 Plastic Probe Protection Bag

019031 451 Filter Cartridge for Purifier

MedGyn MTA-100 Thermal Ablation System

The MedGyn MTA-100 Thermal Ablation System is now designed with both battery and electrical cord options, ensuring reliable performance whether mobility or continuous power is your priority. Choose the power source that best supports your patient’s needs and your clinical workflow. With compatibility for 110V and 220V, the MTA-100 ensures reliable performance in clinics and hospitals worldwide.

- Battery or Electricity as dual power options for greater flexibility
- Optimized to offer 20, 40, or 60 second intervals for procedure
- Bright LED lights for clear viewing of cervical area.
- Sound and light activation for beginning and end of procedure.
- Digital display to detailing temperature at all stages of procedure
- Durable and ergonomic handle for ease of use
- 25mm tip available offering larger treatment area



018003

Battery, Charger and AC Adaptor Included



018003-CS

018003 MedGyn MTA-100 Thermal Ablation System * Patented

018003-CS Thermal Ablation System Case



018003-RB Thermal Ablation System Rechargeable Battery



018003-BC Thermal Ablation System Rechargeable Battery Charger

**International Only*

MedGyn MTA-100 Tips

Safe, interchangeable, autoclavable tips are made from a conductive gold alloy, to allow for various precancerous lesion treatment sizes.

	018003/2500 Exocervical, 25mm, Flat
	018003/2507 Endo/Exocervical, Large
	018003/1910 Endo/Exocervical, Small

	018003/1905 Exocervical, Convex, 19mm x 5mm
	018003/1600 Exocervical, 16mm, Flat
	018003/1900 Exocervical, 19mm, Flat

MedGyn Electrosurgical Generator System

MedGyn Electrosurgical Generator Complete System includes the ES Generator, Smoke Evacuator, and trolley.

018011 MedGyn Electrosurgical Generator Complete System includes the ES Generator, Smoke Evacuator, and Trolley

018102 MedGyn Electrosurgical Generator Trolley
**International Only*



018011

MedGyn Smoke Evacuators

Smoke filtration system minimizes airborne microbes and viruses while removing smoke from site for improved visualization for use during all electrosurgical procedures.



018100

018100 MedGyn Smoke Evacuator (110V)

018109 MedGyn Smoke Evacuator System (220V)



018109

**International Only*

Smoke Evacuator Accessories

018105 Smoke Filter Tube for MedGyn Smoke Evacuator (Single use, Sterile - 110V or 220V) (5/Box)

018106 Disposable Smoke Evacuator (DSE) Male Tubing 8" (Non-Sterile) (50/Box)



MedGyn Electrosurgical Generators (ES Series)

The MedGyn ES-100, ES-200, ES-300, ES-400 Electrosurgical Generator Series meet all demands for a LEEP/ LLETZ procedure. MedGyn's generators feature both monopolar and bipolar functions to satisfy all surgical demands with safety, flexibility, reliability, and convenience.

- Pure cut and blend cut functions
- Contact coagulation and bipolar coagulation
- Displays output power digitally
- Allows operator to check output power easily during the procedure
- Power source: AC120V or AC230V, 50/60 Hz (manual switch)

018015 MedGyn ES-100: Electrosurgical Generator (110-220V)
(Includes Single Foot Switch, Disposable Twin Button Handle, Silicone Patient Plate)

018120 MedGyn ES-200: Electrosurgical Generator (220V)
(Includes Single and Double Foot Switch, Disposable Twin Button Handle, Silicone Patient Plate)

018130 MedGyn ES-300: Electrosurgical Generator (220V)
(Includes Single and Double Foot Switch, Disposable Twin Button Handle, Silicone Patient Plate)

018135 MedGyn ES-400: Electrosurgical Generator (220V)
(Includes Single and Double Foot Switch, Disposable Twin Button Handle, Silicone Patient Plate)

**International Only*



018135



018015

Accessories for Electrosurgical Generators

028033 Disposable Grounding Pads with Cable



028030 Disposable Handswitch Pencil (single use)



028031 Disposable Grounding Pads without Cable

028032 Reusable Handswitch Pencil



BF01-01R Bipolar Forceps - Bayonet 17.8cm 1.0 Tip



BF01-02R Bipolar Forceps Bayonet 15.2cm 1.0 Tip



BF02-01R Bipolar Forceps - Straight 9.0cm 0.5 Tip



BF02-02R Bipolar Forceps Straight 12.1cm 1.0 Tip



BF02-03R Bipolar Forceps - Straight 17.8cm 1.0 Tip



BF03-01R Bipolar Forceps Angled 0.9cm 0.5 Tip		BF03-02R Bipolar Forceps - Angled 17.8cm 1.0 Tip	
CA01-01R Bipolar Forceps Cable 2pin Plug Cable 3mEN Type Connector		CA02-02R Patient Return Plate Cable- 6.3 Pie Plug Silicon Cable 3m For ES-100	
CA02-03R Patient Return Plate Cable-Valley Lab Type Plug Silicon Cable 3m For ES-200/300/400		CA03-01R Ground Cable - Cable 4Ø, 3m	
FS01-02R Single Foot Switch - 3pin Plug Cable 4m		FS02-01R Double Foot Switch - 4pin Plug Cable 4m	
HD01-01R Mono Polar Handle & Cable- Silicon Cable 4Ø 3m For Es-200/300/400		HD02-01D Disposable Twin Button Handle - 3Pin Plug Cable 3m	
PL02-04R Silicon Patient Plate - 240mm x 150mm Valley Lab Type Plug Cable 3m		CT01-01R Cart - W390xD480x H850(mm)	

O28034 Reusable Cable Only for Disposable Grounding Pad	EL03-02D Electrode - Loop 6mm Black
HD01-02R Mono Polar Handle & Cable - Silicon Cable 4Ø 3m For ES-100	EL04-02D Electrode - Needle 2.4 * 70mm Black
PL02-04R Silicon Patient Plate - 240mm x 150mm Valley Lab Type Plug Cable 3m	EL04-04D Electrode - Needle Angled 45° 2.4 * 70mm, Black
PL03-02D Disposable Patient Plate (2ea) - Adult Dual (120cm ²) For ES-200/300/400	ST03-01R Latex Strap Perforated - 600mm x 1250mm, 60 hole
PL03-03D Disposable Patient Plate (2ea) - Adult Dual (68cm ²) For ES-100	PL03-03D Disposable Patient Plate - Pediatric Dual (66cm ²)
CA02-02R Patient Return Plate Cable - 6.3 Pie Plug Silicon Cable 3m For ES-100	BF01-02R Bipolar Forceps - Bayonet 15.2cm 1.0 Tip
CA02-03R Patient Return Plate Cable - Valley Lab Type Plug Silicon Cable 3m For ES- 200/300/400	BF02-01R Bipolar Forceps - Straight 9.0cm 0.5 Tip
CA03-01R Ground Cable - Cable 4Ø, 3m	BF02-02R Bipolar Forceps - Straight 12.1cm 1.0 Tip
CA01-01R Bipolar Forceps Cable - 2pin Plug Cable 3mEN Type Connector	BF02-03R Bipolar Forceps - Straight 17.8cm 1.0 Tip
BF01-01R Bipolar Forceps - Bayonet 17.8cm 1.0 Tip	BF03-01R Bipolar Forceps - Angled 9.0cm 0.5 Tip
EL01-02D Electrode - Knife 2.4 * 70mm Black	BF03-02R Bipolar Forceps - Angled 17.8cm 1.0 Tip
EL02-02D Electrode - Ball 5mm Black	CT01-01R Cart - W390xD480xH850(mm)

MedGyn Fetal Monitors – "F" Series

MedGyn's F6 & F9 Fetal and Maternal Monitor series combine simultaneous mother and baby monitoring. These monitors offer powerful patient information management and centralized monitoring system compatibility with a color display.

- 10.2" foldable wide color screen
- 24-hour CTG storage
- Built-in thermal array printer
- Data management software for real-time data transmission to PC
- Intrapartum monitoring (DECG/IUP) (Optional)
- The F6 Express offers the same superior features as the F6 System but with maternal monitoring included

017118 MedGyn F6 Fetal Monitor (FM10)

017119 MedGyn F6 Fetal Monitor (FM10) Twin FHR

017120 MedGyn F6 Express Fetal Monitor (FM10)

The F9 Fetal Monitor offers the same superior features as the F6 Fetal Monitor plus a foldable 12" color screen

017122 MedGyn F9 Fetal Monitor

017123 MedGyn F9 Express Fetal Monitor

**International Only*



017118



017122

Fetal Monitor Accessories

017105 Strap for Fetal Monitor F6



017191 Recording Paper for Fetal Monitor F6



017106 Battery for Fetal Monitor F6



017192 Recording Paper for Fetal Monitor F9



017125 Fetal Monitor Stand (Adjustable with Rolling Base)

MedGyn Ultrasonic Pocket Doppler

MedGyn Pocket Doppler combines reliable and accurate detection with easy-to-use, light-weight design. Available with rechargeable batteries and probe frequency options.

- Easy-to-read, back-lit LCD display
- Built-in recorder
- Accurate FHR detection with sound
- Automatic and manual FHR counting
- Interchangeable waterproof probes

- 017101 Ultrasonic Pocket Doppler with 2MHz Probe
- 017126 Ultrasonic Pocket Doppler with 3MHz Probe
- 017102 Ultrasonic Pocket Doppler with 2MHz Probe Rechargeable
- 017127 Ultrasonic Pocket Doppler with 3MHz Probe Rechargeable
- 017100 MedGyn Ultrasonic Pocket Doppler (2MHz Probe)

**International Only*

Ultrasonic Pocket Doppler Accessories

- 017128 2MHz Probe
- 017129 3MHz Probe
- 017130 4 MHz Probe
- 017132 5 MHz Probe
- 017131 8 MHz Probe



017101



017100

MedGyn Ultrasonic Table-Top Doppler

MedGyn Table-Top Dopplers are innovative additions to our Doppler category in a portable, light-weight package. Available in both wireless/infrared and wired models.

- Easy-to-read, back-lit LCD display
- Built-in recorder
- Accurate FHR calculation
- Portable lightweight design

- 017150 SD5 Table-Top Doppler with 2MHz probe, wired
- 017151 SD6 Table-Top Doppler with 2MHz probe, wireless



017150
SD5 Table-Top Doppler (Wired)

Ultrasonic Table-Top Doppler Accessories

- 017155 2MHz Probe, Wired for SD5
- 017157 3MHz Probe, Wired for SD5
- 017156 2MHz Probe, Wireless for SD6
- 017158 3MHz Probe, Wireless for SD6
- 017159 Carry Bag for SD5/SD6
- 017160 Rolling Stand for SD5/SD6
- 017199 Doppler Gel 8oz



017151
SD6 Table-Top Doppler (Wireless)

MedGyn LED-100 Examination Lamp

MedGyn LED-100 Examination Lamp is used to assist in performing clinical and gynecological exams. The Lamp has a flexible, chrome-plated, top base with four casters for excellent maneuverability and stability. The LED-100 provides three times better light output than standard lamps with exceptional longevity and brightness

- Highly flexible LED light is easy to maneuver
- True tissue color rendition and pinpoint accuracy
- Power dual voltage 110V or 240V, 60/50Hz
- Illuminance of 20,000 lux (Distance of 50 cm)
- Minimum expected life of LED is 35,000 hours
- Net weight: 5 kg (10.2 lb)
- Variable height of 110cm and 150 cm (95.5lb x 130lb)
- Electrical Standards: NBR-IEC 60.601-1 and NBR-IEC 60.601-1-2

010551 MedGyn LED-100 Examination Lamp
(Includes Rolling base with 4 Casters)



010551

MedGyn HVP-100 Hand-Held Vacuum Delivery Pump

MedGyn Hand-Held Vacuum Delivery Pump may be used to safely assist medical personnel during vaginal deliveries. MedGyn Vacuum Delivery Cups offer optimal adhesion to ensure proper vacuum levels.

016160 MedGyn HVP-100 Hand-Held Vacuum Delivery Pump
**International Only*



016160

MedGyn Vacuum Assisted Delivery Cups

- Smooth, soft silicone is designed to be gentle on maternal and fetal tissue during birth
- Silicone cup connects to an external vacuum source for precise control and consistent vacuum levels
- Available in two sizes 50mm and 60mm I.D.
- Available with or without release valve

020322 MedGyn Vacuum Delivery Cups 50mm with Release Valve

020323 MedGyn Vacuum Delivery Cups 60mm with Release Valve

020316 MedGyn Vacuum Delivery Cups 70mm with Release Valve

020320 Vacuum Delivery Cup 50mm

020321 Vacuum Delivery Cup 60mm

**International Only*



020322

020320

MedGyn Synevac 12/ MVP-100 Vacuum Pump

MedGyn Synevac 12/ MVP-100 Vacuum Pump is designed for safety and convenience. It features a push-switch linked directly to the pump and a built in anti-overflow device.

- Heavy-duty
- Oil-less piston vacuum pump
- Built-in anti-overflow device
- Push switch (red button) is linked directly to pump which lets the operator easily check the status
- Controlled low-voltage for user safety (under DC 12V)
- Quiet pump

016155 MedGyn Synevac 12/ MVP-100: Vacuum Pump
(Includes Foot Switch, Collection Bottle)



016155

MedGyn Portable Vacuum Pump

MedGyn's Portable Vacuum Pump is a battery-operated pump with a oil-free piston and is maintenance free.

- Oil-less piston requiring no lubrication and no maintenance
- 1000 mL autoclavable collection jar
- 12V rechargeable battery for two hours of operation

016156 MedGyn Portable Vacuum Pump
022316 Suction Tube 2m for MedGyn Portable Pump
022321 Suction Filter with Side Tube for MedGyn Portable Pump
022322 Suction Bottle with Bottle Cap for MedGyn Portable Pump

**International Only*



016156

MedGyn Disposable Colposcopy Kit

- Ready-to-use, sterile packaging saves time
- Eliminates risk of cross-contamination
- Promotes procedural reliability and confidence
- Frees clinical staff from reprocessing tasks
- Allows more focus on patient care and clinical support



Kit Contents:

- Large plastic tray, 10.5"x12.3"x1" 1 ea.
- Small plastic tray, 5.3"x4.8"x 2" 1ea.
- Disposable LED Speculum 1ea.
- Cervical dilator/Os Finder 1ea.
- Tenaculum hook, pozyzy 1ea.
- Cherron Forceps 1ea.
- Monsel's Solution, 8mL 1ea.
- Cotton swab, 8" 2ea.
- Sanitary napkin 1ea.
- Sterile Gauze 2ea.
- Over wrap, 30"x30" 1ea.
- Povidone-iodine solution, 0.75 Fl. oz
- Sponge swab 2ea.

030090 Disposable Colposcopy Set

030091 Disposable Colposcopy Set with Rotating Biopsy Punch

030092 Disposable Colposcopy Set with Tischler Biopsy Punch

030093 Disposable Colposcopy Set with Baby Tischler Biopsy Punch

MedGyn Endometrial Biopsy Kit

- Includes all the essentials for a safe endometrial biopsy
- Smooth, patient conscious design
- Saves time and expense



Kit Contents:

- Disposable LED Speculum - Medium
- Disposable Uterine Sound
- Disposable Metal Pozzi Tenaculum
- Disposable Metal Ring Forceps
- Disposable Metal Littaur Scissors
- Towel
- Endosampler™
- Pipette
- Disposable Os Finder (Blue)
- Disposable Os Finder (Green)
- Gauze
- 2 Cotton Swabs
- Plastic Tray (16" x 4 1/2")
- Wrap (blue)

022796 Disposable Endometrial Biopsy Kit

MedGyn HSG Procedure Tray

Conveniently prep for a safe and efficient HSG or SHG procedure with zero risk of cross-contamination.

- French Size: 5Fr | 7Fr
- Sterilization Method: ETO
- PVC Free & Non-DEHP

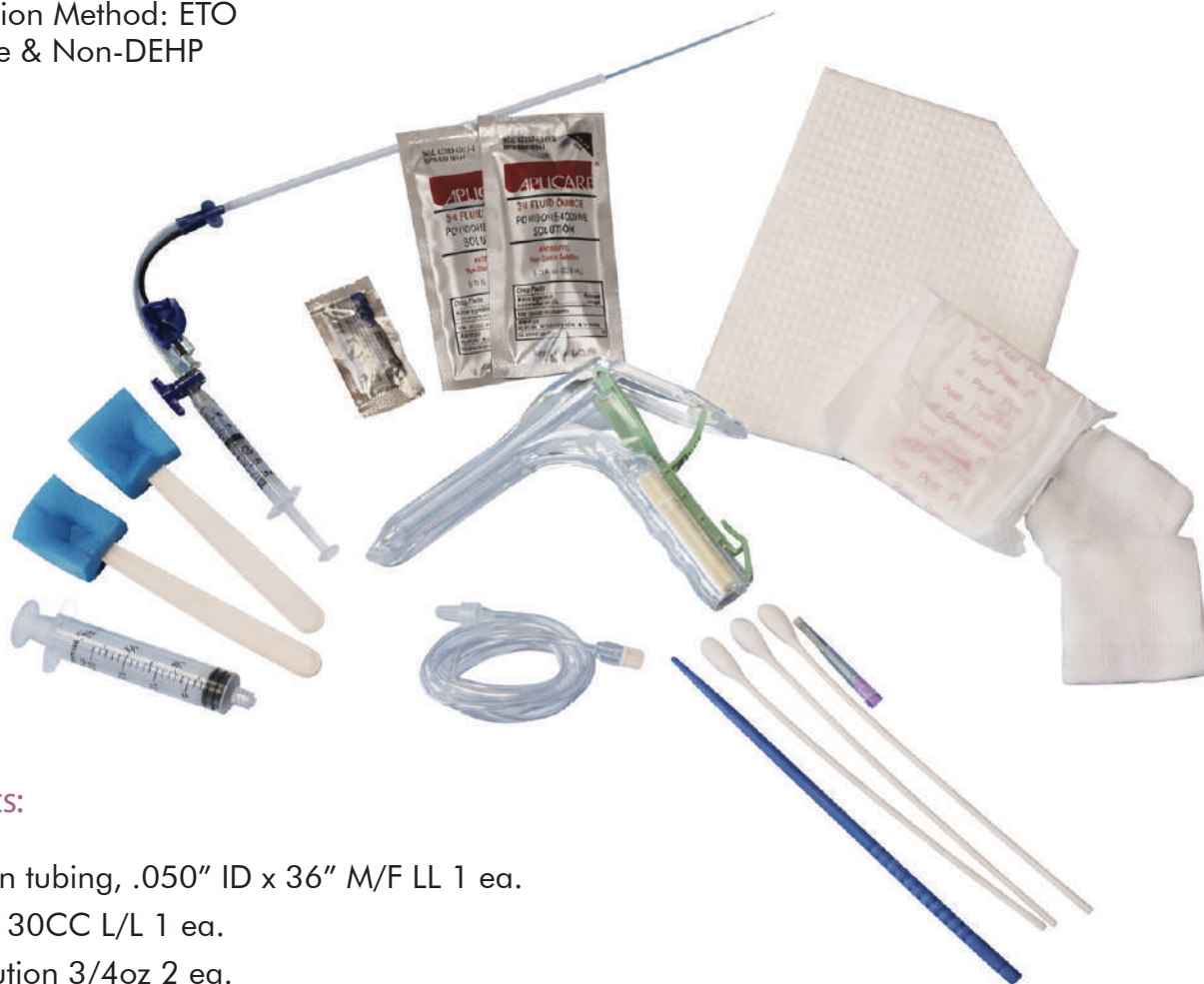

Kit Contents:

- Extension tubing, .050" ID x 36" M/F LL 1 ea.
- Syringe, 30CC L/L 1 ea.
- PVP Solution 3/4oz 2 ea.
- Jelly, Lubricating 3g. 1 pk.
- Drape with 2 1/2 Fenestration, 18" x 26" 1 ea.
- Needle, 18 G x 1 1/2 1 ea.
- Gauze, 3"x 3" 4ply 5 ea.
- Sterile Gauze, 3x3 12ply 2 ea.
- Pad, Maxi 1 ea.
- Swab, Cotton 8" 3 ea.
- Bag, Header 22" X 10.25" X 5" 1 ea.
- MedGyn Disposable LED Speculum 1 ea.
- Wrap, Poly 30" x 30" 1 ea.
- Tray, 16" x 6.6" x 2.3" 1 ea.
- Tray, 5.3" x 4.5" x 2" 1 ea.
- Cervical Dilator 1 ea.
- Sponge Stick, 6" 2 ea.

- TMI1157** HSG Procedure Kit without Catheter
- TMI1160** HSG Procedure Kit with 5Fr Flexible HSG Catheter
- TMI1161** HSG Procedure Kit with 7Fr Flexible HSG Catheter
- TMI1198** HSG Procedure Kit with 5Fr Shapeable HSG Catheter
- TMI1199** HSG Procedure Kit with 7Fr Shapeable HSG Catheter

MedGyn IUD Kit

- Sterile, single use kit contains everything needed to insert or remove an intrauterine device
- Kit includes: Cherron Forceps, Pozzy Forceps, Scissors, and Uterine Sound
- Available in a single-use metal option



022365 MedGyn IUD Kit consists of Cherron Forceps, Pozzy Forceps, Long Littauer Scissors, Uterine Sound (25/Box)

022365-M IUD Kit consisting of Metal Cherron Forceps, Pozzy Forceps, Long Littauer Scissors, Uterine Sound (25/box)

MedGyn Os Finder Set

- Gently opens external cervical os
- Made of smooth, malleable plastic
- Disposable to ensure safety and lower cost of re-sterilization procedure

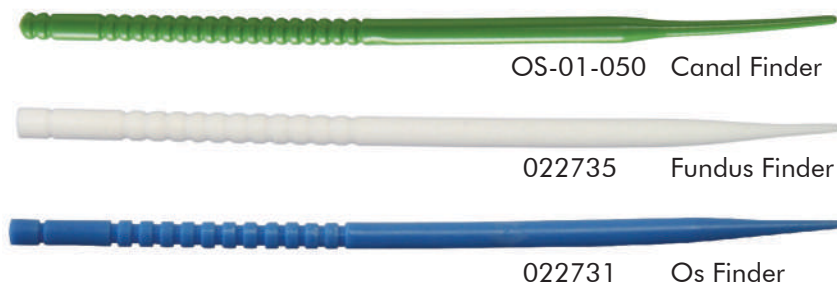

022733 Disposable Os Finder Set (Os Finder, Canal Finder, and Fundus Finder) (Pack of 10/Box)

MedGyn Manual Vacuum Aspiration (MVA) Kit

- Multi-setting versatility
- Gentle, quiet, and safe
- Convenient in one disposable, sterile kit
- Time efficient and cost effective



Kit Contents:

- MedGyn Double Valve Aspirator 1ea.
- Denniston Cervical Dilators (sizes 5/6, 7/8, 9/10mm) 3 total
- MedGyn Karman Curettes (sizes 6, 7, 8, 9mm) 4 total
- Ring Forcep 1ea.
- Drape with 2 1/2" fenestration 1ea.
- Sponge prep stick 1ea.
- Blue wrap (30" x 30") 1ea.
- Clear tray (16" x 6.6" x 2.3") 1ea.
- Clear tray (5.3" x 4.5" x 2") 1ea.
- Header bag (22" x 10.25" x 5") 1ea.
- Gauze, 4-ply (3" x 3") 5ea.

022527-X Manual Vacuum Aspiration (MVA) Kit

022527 Manual Vacuum Aspiration (MVA) Kit

*International Only

MVA Kit for export includes all of the above content except ring forceps and sponge prep stick

MedGyn Endosampler™

The unique design of the MedGyn Endosampler™ allows for superior accuracy and a more reliable sample. Available with one or two holes for the right amount of suction for each patient.

Just one insertion for a perfect sample

- 3mm curette and 10cc syringe
- Highly-visible graduated markings
- Semi-rigid curette
- Curved for improved manipulation
- Prevent back-flow with syringe lock-spring
- Sharp slot in curette tip
- "Closed" system prevents sample contamination

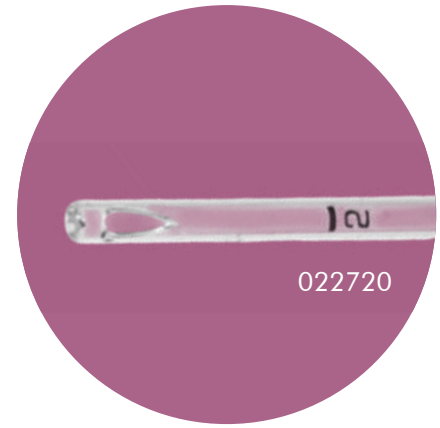

022720



022722

- 022720 MedGyn Endosampler™ (25/Box)
022722 MedGyn Endosampler II™ (25/Box)

MedGyn Pipette™

The MedGyn Pipette™ and Pipette IV™ are unique, sterile, disposable cannulas for sampling the endometrium.

- Semi-rigid and tapered for easy insertion and safety
- Flexible enough to collect tissue from all areas
- Yield specimens highly suitable for both cytologic and histologic diagnosis

022721 MedGyn Pipette 3.1mm O.D. (25/box)

022730 MedGyn Pipette IV 3.1mm O.D. (25/box)

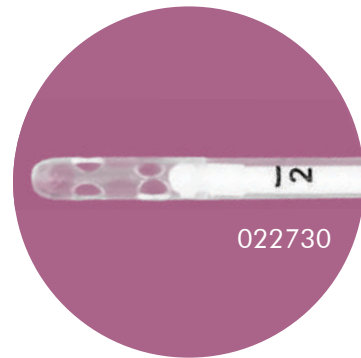
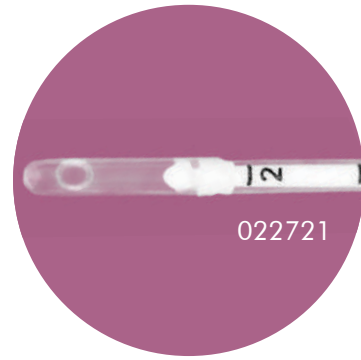

MedGyn Endocervical Curette

The MedGyn Endocervical Curette provides an efficient sampling of the cervical canal to test for abnormal, precancerous conditions, or cervical cancer.

- The Kevorkian-Younger endocervical curette is a sterile, single-use device with a basket and a square tip.

022732 MedGyn Disposable Endocervical Curette (25/Box)

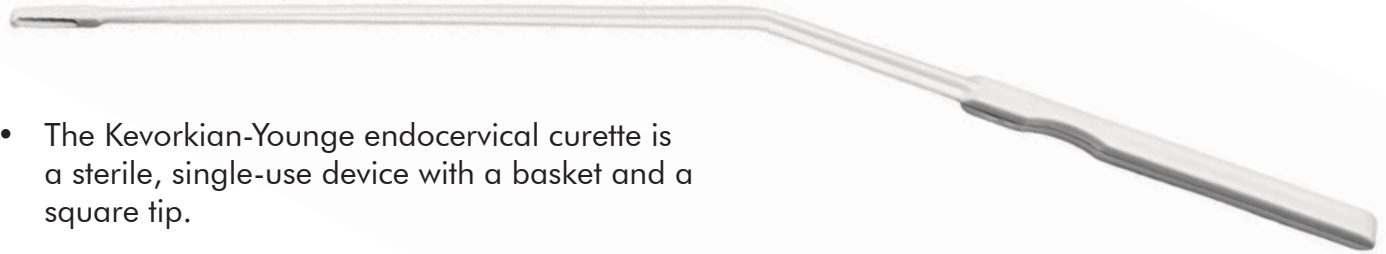

MedGyn Mucous Sampler

The MedGyn Mucous Sampler is a single-use, sterile, endocervical aspirator.



- 23 cm long, clear, flexible polypropylene tube
- 2.2mm diameter circular opening
- Distal end rounded for safety

022729 MedGyn Disposable Mucous Sampler (25/pack)

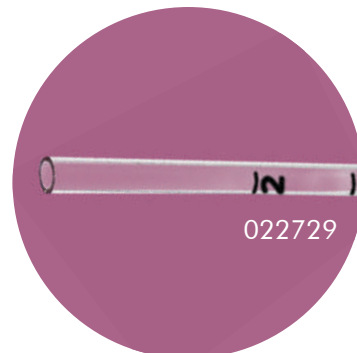

MedGyn Cell Sweep®

The MedGyn Cell Sweep® makes pap smears easier than ever by simultaneously sampling both the endocervix and ectocervix, eliminating the need for both a cytobrush and spatula.

- Soft, malleable, and adaptable to individual cervical variations
- The design and specific structure of Cell Sweep enables the cervix to be sampled twice,
- simultaneously, in a 360° motion



022362

- 022362 MedGyn Cell Sweep® Slide Holder (100/pack)
- 022361 MedGyn Cell Sweep® Non-Sterile (100/pack)
- 022361K MedGyn Cell Sweep® Non-Sterile with Kit (Slide and Slide Holder) (100/pack)
- 022363 MedGyn Cell Sweep® Sterile (100/pack)
- 022363K MedGyn Cell Sweep® Sterile with Kit (Slide and Slide Holder) (100/pack)



022363

MedGyn Cytobrush

- Soft, flexible nylon bristles for effective endocervical cell collection
- Tapered brush design for optimal sampling

MedGyn Pap Cell

- Contoured tip designed to fit the cervical os and ectocervix
- Smooth edges for patient comfort

- 022710 MedGyn Cytobrush (100/Box)
- 022364 MedGyn Pap Cell (50/Box)



022364

022710

MedGyn Monsel's Solution

Ferric Subsulfate Solution 20% is an effective hemostatic solution for use after cervical biopsies.

- 022610 Monsel's Solution - 8mL bottle (12/Box)
- 022612 Monsel's Solution - 500mL bottle - suspension



MedGyn Single-Use Forceps

Designed for gynecologic surgical and oncologic procedures, these single-use forceps deliver reliable performance with exceptional strength and precision, crafted from high-grade medical-quality stainless steel.



- 029701-D Tischler Biopsy Single-Use Forceps, 9 3/4" (10/Pack)



- 029702-D Baby Tischler Biopsy Single-Use Forceps, 9 3/4" (10/Pack)



029703-D

029703-D Kevorkian-Younger Biopsy Single-Use Forceps 9 3/4" (10/Pack)

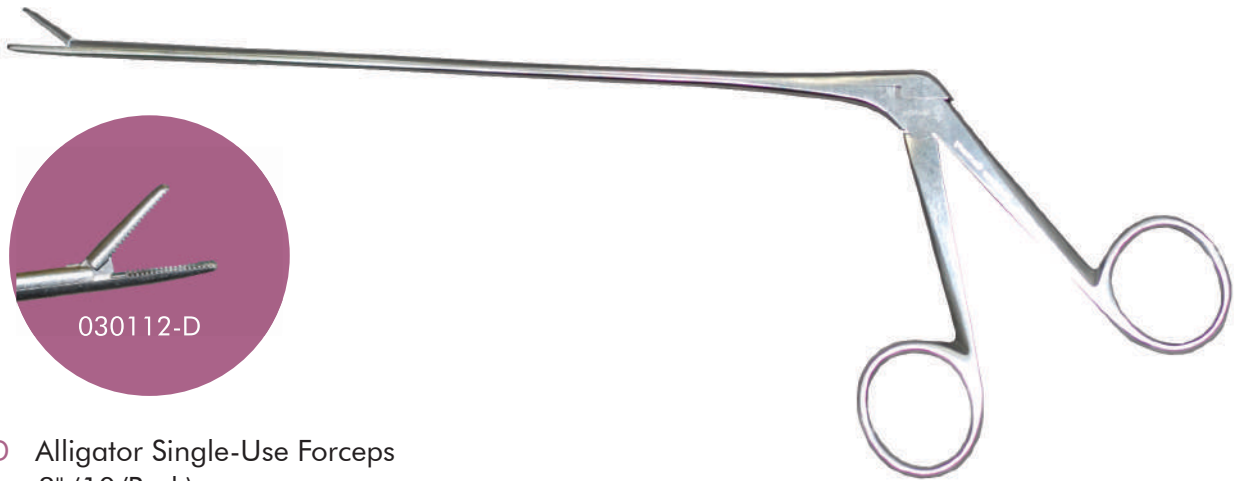

030112-D

030112-D Alligator Single-Use Forceps 8" (10/Pack)

MedGyn Rotating Biopsy Punch

MedGyn's Rotating Biopsy Punch is our latest single-use device with a plastic handle and stainless steel shaft to sample cervical tissue.

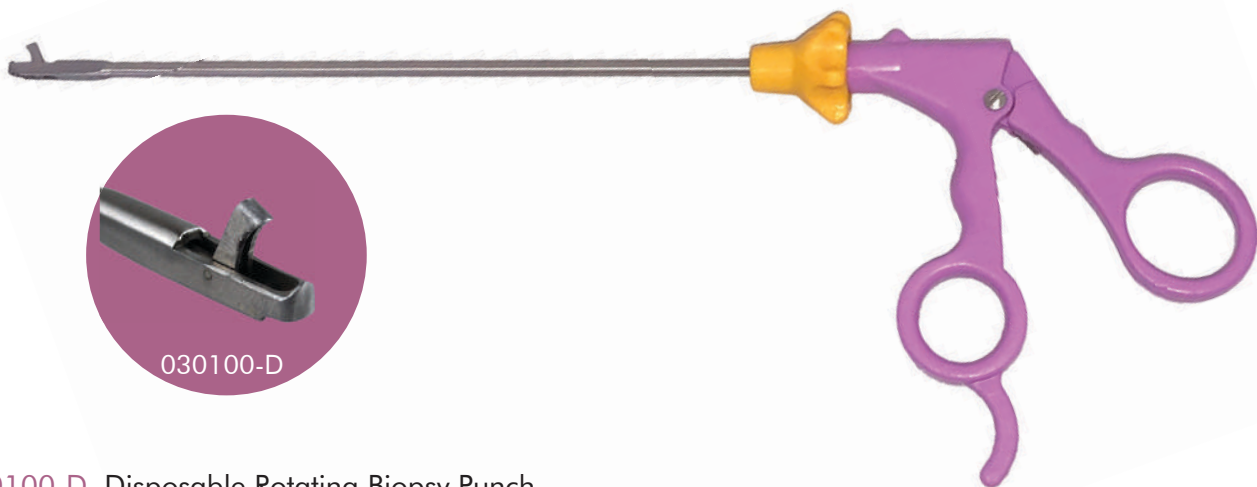

030100-D

030100-D Disposable Rotating Biopsy Punch

MedGyn Disposable Electrodes

Made of high-quality Tungsten wire, for superior shape and integrity, MedGyn offers a full range of shapes and sizes to suit most electrosurgical procedures.

Interchangeable with most electrosurgery units

Loop Electrodes			
Product #	mm.	Per Pack	
028067	5mm x 5mm	5/Pack	
028069	10mm x 5mm	5/Pack	
028070	10mm x 7mm	5/Pack	
028071	10mm x 8mm	5/Pack	
028055	10mm x 10mm	5/Pack	
028056	10mm x 13mm	5/Pack	
028057	15mm x 5mm	5/Pack	
028087	15mm x 7mm	5/Pack	
028058	15mm x 8mm	5/Pack	
028068	15mm x 10mm	5/Pack	
028078	15mm x 12mm	5/Pack	
028076	15mm x 13mm	5/Pack	
028059	15mm x 15mm	5/Pack	
028060	20mm x 8mm	5/Pack	
028063	20mm x 10mm	5/Pack	
028061	20mm x 12mm	5/Pack	
028062	20mm x 13mm	5/Pack	
028064	20mm x 15mm	5/Pack	
028065	20mm x 20mm	5/Pack	
028066	25mm x 10mm	5/Pack	

Square Electrodes		
Product #	mm.	Per Pack
028075	5mm x 5mm	5/Pack
028072	10mm x 4mm	5/Pack
028073	10mm x 8mm	5/Pack
028074	10mm x 10mm	5/Pack

Ball Electrodes		
Product #	mm.	Per Pack
028041	3mm	5/Pack
028042	5mm	5/Pack

Needle Electrode		
Product #	mm.	Per Pack
028053	5mm	5/Pack

Blade Electrode	
Product #	Per Pack
028081	5/Pack



MedGyn HSG / SHG Catheters

Flexible & Shapeable HSG Catheter

MedGyn HSG Catheter is used to inject contrast media or saline into the uterus and fallopian tubes for hysterosalpingography and sonohysterography procedures. It has a latex-free balloon catheter with a malleable placement sheath.

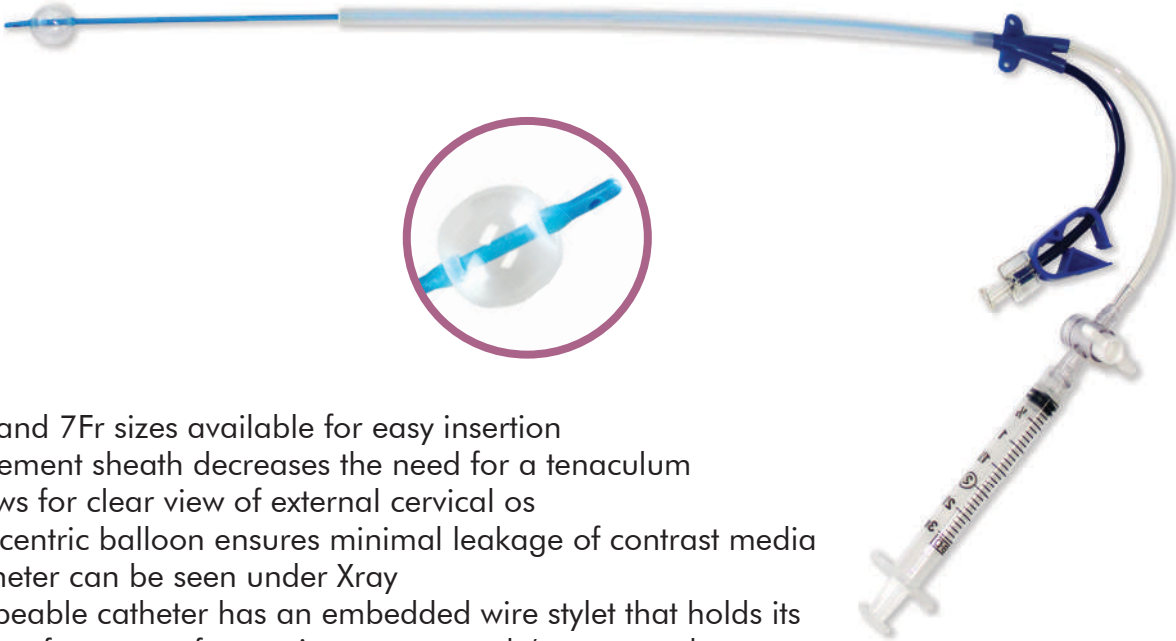

- 5Fr and 7Fr sizes available for easy insertion
- Placement sheath decreases the need for a tenaculum
- Allows for clear view of external cervical os
- Concentric balloon ensures minimal leakage of contrast media
- Catheter can be seen under Xray
- Shapeable catheter has an embedded wire stylet that holds its shape, for cases of stenosis or anteverted / retroverted uterus
- 28cm in length

022726 MedGyn Flexible HSG Catheters - 5Fr (10/Box)

022728 MedGyn Flexible HSG Catheters - 7Fr (10/Box)

TMI1185 MedGyn Shapeable HSG Catheters - 5Fr (10/Box)

TMI1187 MedGyn Shapeable HSG Catheters - 7Fr (10/Box)

*Equivalent to TMI1154/ TMI1155 HSG Catheters

Steen Open-Tip HSG Catheter

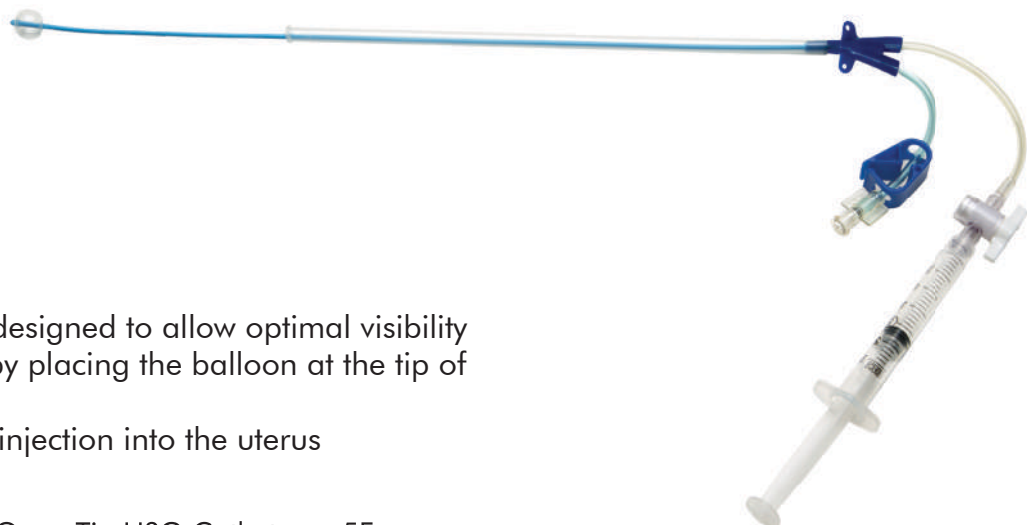

- Open-tip catheter is designed to allow optimal visibility of uterine structures by placing the balloon at the tip of the catheter shaft
- Distal end allows for injection into the uterus
- 28cm in length

TMI1188 MedGyn Steen Open-Tip HSG Catheters - 5Fr

Miller Advance HSG Catheter

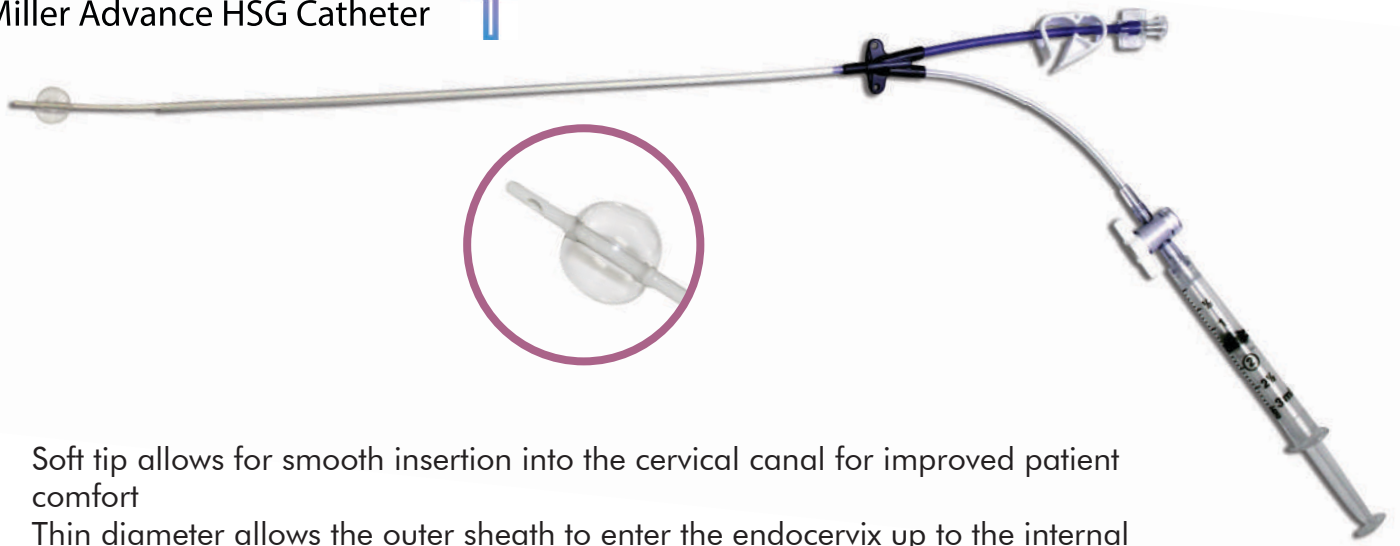

- Soft tip allows for smooth insertion into the cervical canal for improved patient comfort
- Thin diameter allows the outer sheath to enter the endocervix up to the internal os with no additional dilation required
- Memory sheath is made of a flexible memory material that allows the catheter to comfortably conform to the shape of the cervix
- 28cm in length

TMI2002 MedGyn Miller Advance Catheter HSG Catheters - 5Fr
(10/Box)

MedGyn EZ Inject Catheter

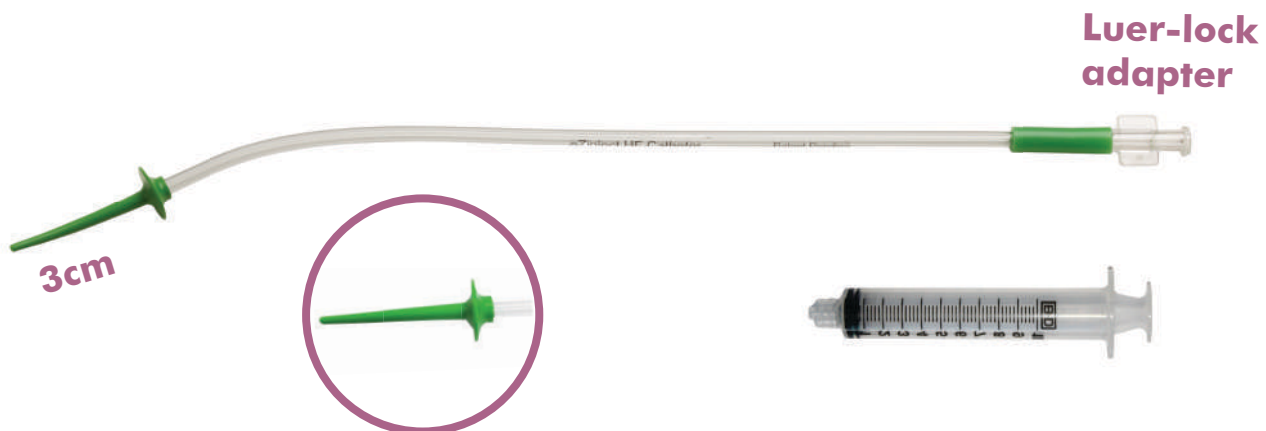

- Balloonless catheter allows for a more complete view
- Long tip at distal end improves placement in the cervical canal
- 24cm in length
- Wide tip opening for increased flow
- Specially deigned tip helps prevent leakage

022797 MedGyn EZ Inject Catheter with 10/cc Syringe (10/box)
*Equivalent to TMI1162-HF

MedGyn IUI Catheters

- Catheter tip is rounded and beveled for patient comfort
- Regular full length is 21cm with two holes at the distal end
- Mini and Mini Curved length is 21cm with a single hole at the distal end

022723 MedGyn Intrauterine Insemination Catheter -
Regular/Straight (25/Box)

022724 MedGyn Intrauterine Insemination Catheter -
Mini (25/Box)

022725 MedGyn Intrauterine Insemination Catheter -
Curved (25/Box)

Clear Shapeable IUI Catheter

- Embedded wire stylet adds rigidity and allows shaping for easier catheter placement in challenging cervical anatomy, including retroversion, anteversion, or cervical stenosis.
- Clear shaft enables the embryologist to see and remove any visible air bubbles, reducing the possibility of uterine spasms and retroflow

TMI1297-18 MedGyn Intrauterine Insemination Catheter -
Clear Shapeable 18cm (25/Box)

TMI1297 MedGyn Intrauterine Insemination Catheter -
Clear Shapeable 23cm (25/Box)

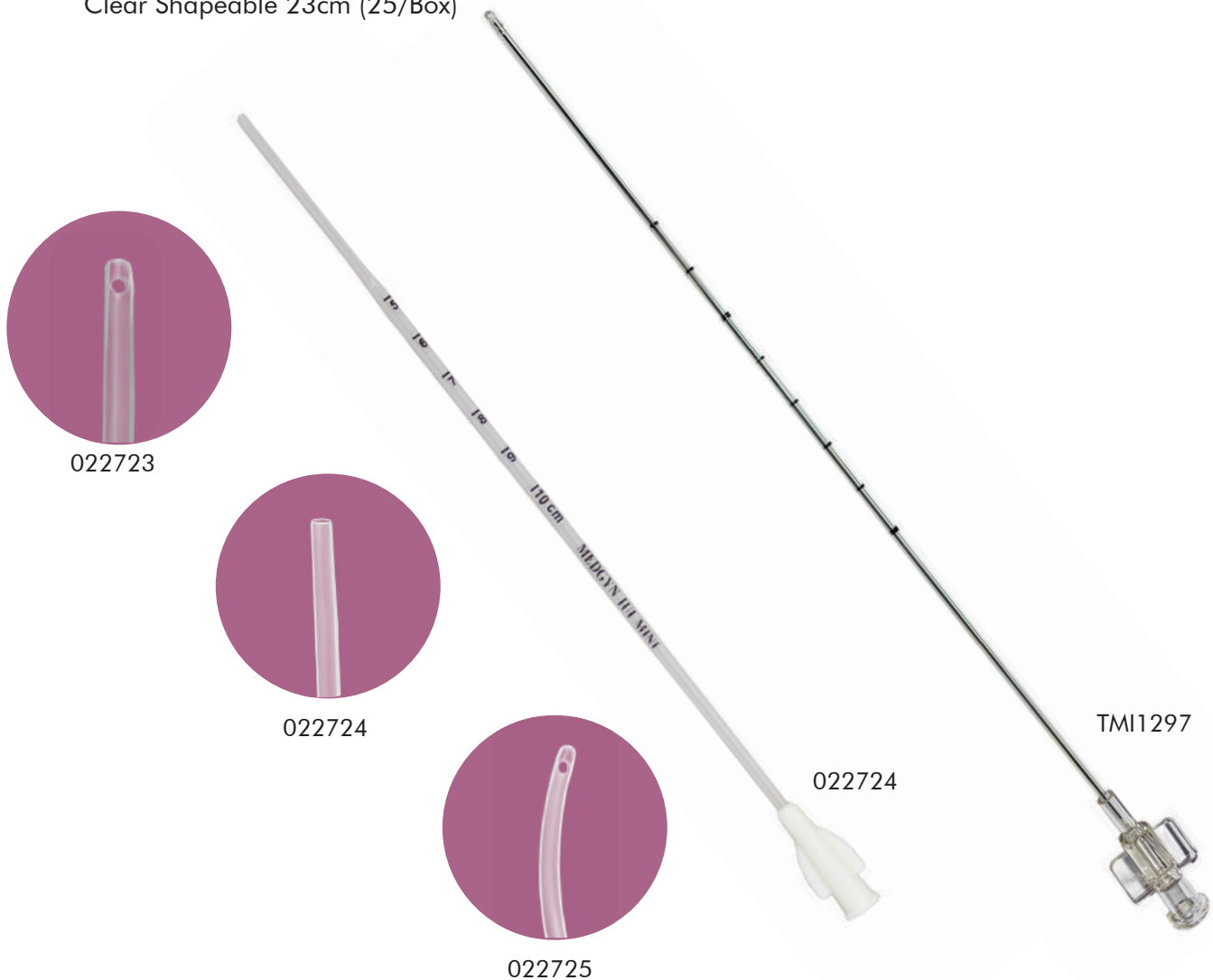

MedGyn Follicle Aspiration Needle

Our Follicle Aspiration Needle is used to harvest ovarian tissue, as well as flush oocytes from the follicles.

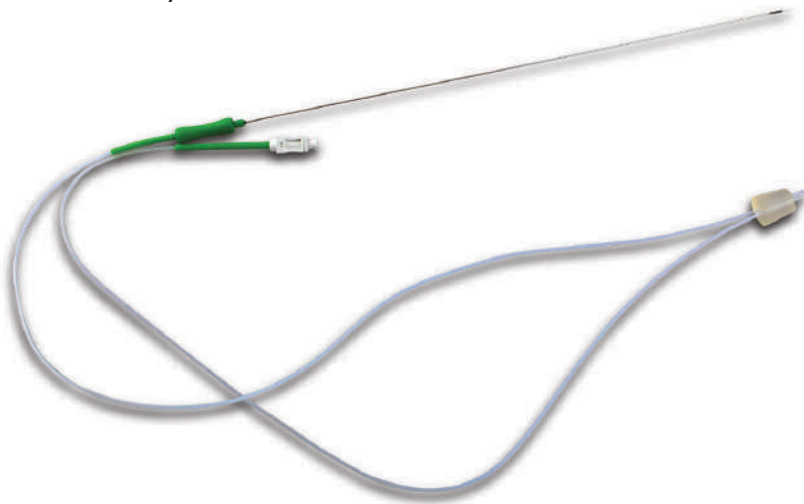

- Echo Marking enables high reflection and visibility for precise guidance with ultrasound used during oocyte retrieval
- Used for ultrasound-guided transvaginal harvesting of oocytes from follicles
- Internal surface of the needle and tubing are extremely smooth which allows safe transfer of egg to test tube
- Enabled flushing of needle and connecting tube after the procedure
- 17 Gauge
- Available in two sizes: 32cm & 35cm / single and double lumen

022699 MedGyn Follicle Aspiration Needle, 32cm, Single Lumen (10/Box)

*Equivalent to TMI1280

TMI1280-35 MedGyn Follicle Aspiration Needle, 35cm, Single Lumen (10/Box)

TMI1282 MedGyn Follicle Aspiration Needle, 32cm, Double Lumen (10/Box)

TMI1282-35 MedGyn Follicle Aspiration Needle, 35cm, Double Lumen (10/Box)

MEA Tested

MedGyn Embryo Transfer Catheter

The Embryo Transfer Catheter is loaded with the embryo and smoothly introduced through the cervical canal up to 1 – 2cm from the uterine fundus, while trying to avoid touching the fundus under ultrasound guidance.

- Guide catheter is curved to facilitate insertion
- Guide catheter's rounded bulb tip eases passage through the cervix
- Guide catheter is 18cm in length
- Transfer catheter is soft and flexible
- Transfer catheter is echogenic which improves visibility under ultrasound
- The cervical stop comes set at 4cm and can be adjusted
- Catheters are packaged in separate sterile pouches

022698 MedGyn Embryo Transfer Catheter

*Equivalent to TMI1290

MEA Tested



MedGyn Micropipettes

Biopsy Micropipette

- Straight, sharp-cut tip
- Polished, smooth edges
- Wide inner diameter

022694 MedGyn Biopsy Micropipette

Holding Micropipette

- Flat, polished tip
- Angled shaft
- Precise outer diameter and suction control

022695 MedGyn Holding Micropipette

ICSI Injection Micropipette

- Ultra-fine, tapered tip
- High-quality, borosilicate glass
- Angle and bevel customization

022696 MedGyn ICSI Injection Micropipette
MEA Tested



MedGyn Vitrification Straws

The MedGyn Vitrification Straws are cryopreservation storage devices utilized in the vitrification procedure to contain and maintain oocytes and embryos.



- Provide reliable oocyte and embryo vitrification
- Straws have great durability and endurance while stored in a liquid nitrogen tank
- Minimal storage space is needed while allowing the maximum quantity of straws in the tank

022697 MedGyn Vitrification Straws

*International Only

MedGyn Laminaria

Laminaria (type of hygroscopic dilator) is a 100% natural sterile cervical dilator made from a sea-grown plant containing no synthetic materials. Safely utilized for over a century, Laminaria provides gentle, gradual dilation. After harvesting, the plant is dehydrated. Once inserted into the cervical canal, Laminaria absorbs liquid, swelling to several times its initial dried diameter, gently dilating the cervix.



Standard, Approximate Length 60mm

- 021002 2mm Extra Small/Extra Thin (25/Box)
- 021003 3mm Small (25/Box)
- 021004 4mm Medium (25/Box)
- 021005 5mm Large/Thick (25/Box)
- 021006 6mm Extra Large/Extra Thick (25/Box)
- 021008 8mm Jumbo (25/Box)
- 021010 10mm Extra Jumbo (25/Box)

Extra Long, Approximate Length 70mm

- 021014 4mm Long 70mm (25/Box)
- 021015 5mm Long 70mm (25/Box)
- 021016 6mm Long 70mm (25/Box)
- 021018 8mm Long 70mm (25/Box)

Long String

- 021003L Laminaria #3 Long-String
- 021004L Laminaria #4 Long-String
- 021005L Laminaria #5 Long-String
- 021006L Laminaria #6 Long-String
- 021008L Laminaria #8 Long-String

With Buttons to Prevent Over Insertion

- 021022 2mm Extra Small with Buttons (12/Box)
- 021023 3mm Small with Buttons (12/Box)
- 021024 4mm Medium with Buttons (12/Box)
- 021025 5mm Large with Buttons (12/Box)
- 021026 6mm Extra Large with Buttons (12/Box)

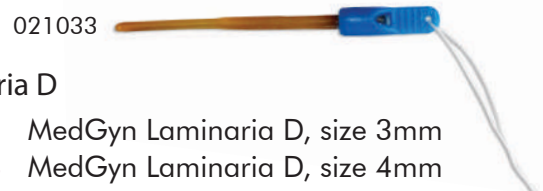

Laminaria D

- 021033 MedGyn Laminaria D, size 3mm
- 021034 MedGyn Laminaria D, size 4mm
- 021035 MedGyn Laminaria D, size 5mm

*International Only

Laminaria Inserter

- 031201 MedGyn Laminaria Inserter
- 031202 McMahan Laminaria Inserter

MedGyn Collection Sets & Accessories

MedGyn Disposable Collection Sets include 6' tubing (either 3/8" or 1/2" I.D.) attached to a control handle with slip-ring for finger-tip vacuum control. The Collection Sets are individually packaged and sterile.



022310



022331



022325



062324



022324



022450



022352



022343



022340



022341

Collection Sets & Bottles

- 022310 3/8" Collection Set with Handle (50/Pack)
- 022310NS 3/8" Collection Set w/Handle & Adapter (Non-Sterile)
- 022310-WO 3/8" Collection Set with Handle (Without Adapter, Sterile) (50/Pack)
- 022314 3/8" Collection Set x 8 Ft with Handle & Adaptor
- 022312 1/2" Collection Set with Handle & Adapter (25/Pack)
- 022312NS 1/2" Collection Set w/Handle & Adapter (Non-Sterile)
- 022331 3/8" Disp. Collection Jar - with Cap (15/Box)
- 022332 1/2" Disp. Collection Jar - with Cap (15/Box)
- 022323 Disp. Tops Large Non-Conductive (10/Box)
- 022324 Disp. Tops Small Non-Conductive (10/Box)
- 022325 Glass Collection Jar - 1400mL
- 062324 Reusable Collection Jar Lid

Metal Swivel Handles

Stainless steel, autoclavable, with slip-ring control

- 022450 3/8" Handle for Currettes up to 14mm with small base
- 022451 1/2" Handle for 14mm, 15mm & 16mm Currettes
- 022340 Stainless Steel 3/8" Female Fitting
- 022341 Stainless Steel 3/8" Male Fitting
- 022343 Stainless Steel 1/2" Male Fitting
- 022352 Stainless Steel 3/8" Handle Extender
- 022353 Stainless Steel 1/2" Handle Extender
- ADAP-REDC 1/2" to 3/8" Adapter for Aspiration Handle (For Small Curette) (10Box)
- 022354 3/8" to 1/2" Adapter for Aspiration Handle (For Large Curette)

Non-Sterile Accessories

- 022316-3/8-6 Tubing 3/8" Precut to 6' (50/Pack)
- 022311 Tubing 3/8", Custom Cut Per Foot
- 022316-1/2-6 Tubing 1/2" Precut to 6' (25/Pack)
- 022313 Tubing 1/2", Custom Cut Per Foot
- 022317 Tubing 16" Connector
- 022318 Tubing 20" Connector
- 022317-ADAP Tube Fitting - Male 3/8" Plastic
- 022317-INT Tube - Interconnecting with Adapter (10/Box)
- 022319-ADAP Tube Fitting - Male 1/2" Plastic
- 022350 Plastic Adapter for 1/2" Base Currettes (Sterile)
- 022351 Plastic Adapter for 1/2" Base Currettes (Non-Sterile)
- O-RING-FAD 3/8" O Ring for Female Adapter (10/Pack)
- 022320 Disposable Filter Assembly (10/Box)

Permeable Gauze Sacks

Gauze collection sack easily attaches to collection canister for simple and efficient separation of tissue from aspirated fluid.

- 022460 Gauze Sacks Tissue Trap (10/Box)
- O-RING3/8 O Ring for 3/8" Sack (10/Box)
- O-RING1/2 O Ring for 1/2" Sack (10/Pack)
- 022461 3/8" O Ring
- 022462 1/2" O Ring

1/2" Collection Set and Curette

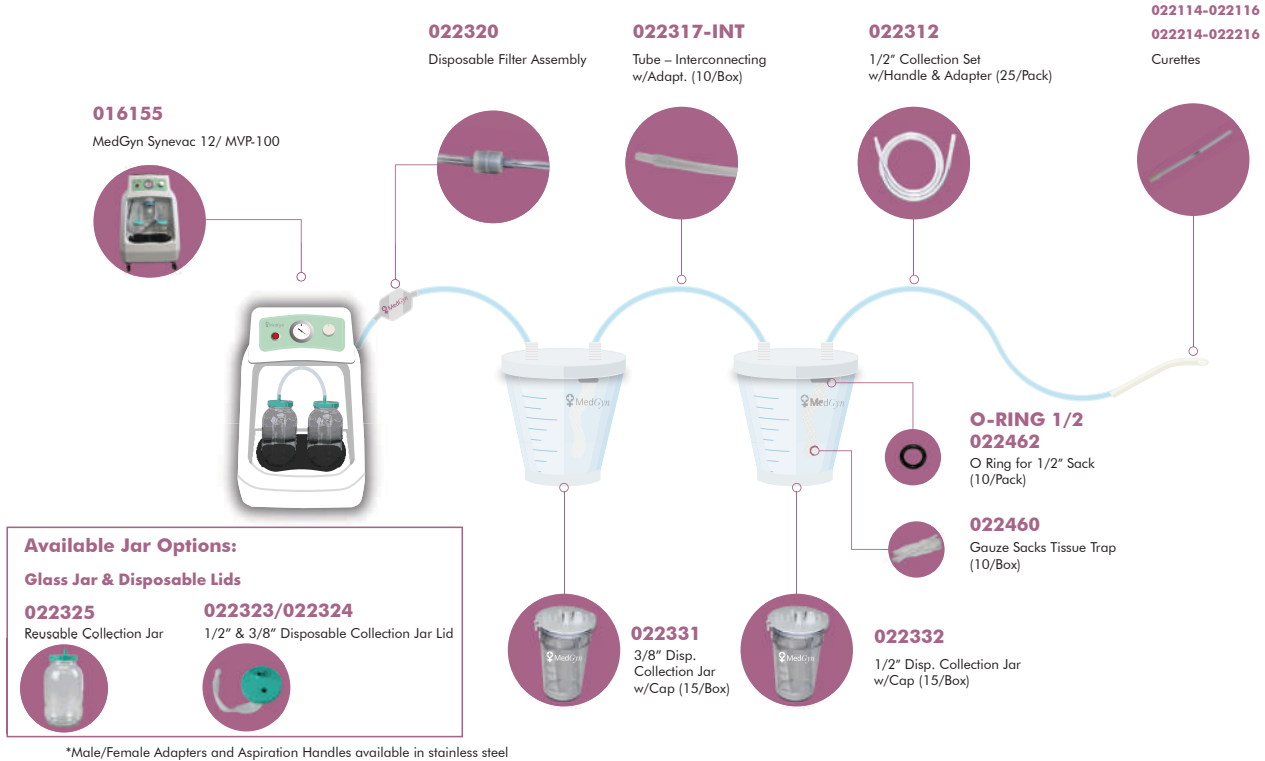

3/8" Collection Set and Curette

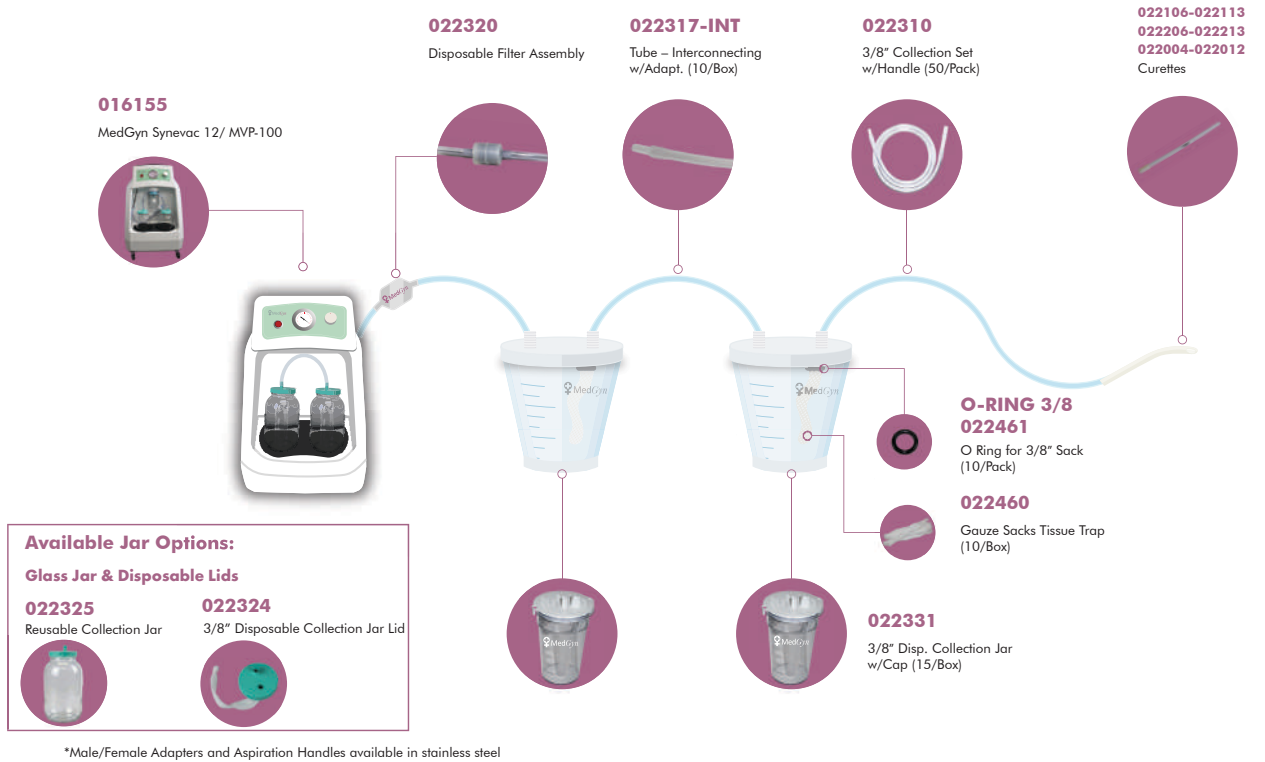

MedGyn Vacuum Cannulas-Curettes

MedGyn offers the most complete line of high-quality, disposable vacuum cannulas-curettes in the industry. Available in Rigid Curved, Rigid Straight, and Flexible options, our cannulas-curettes are individually packaged and sterilized.

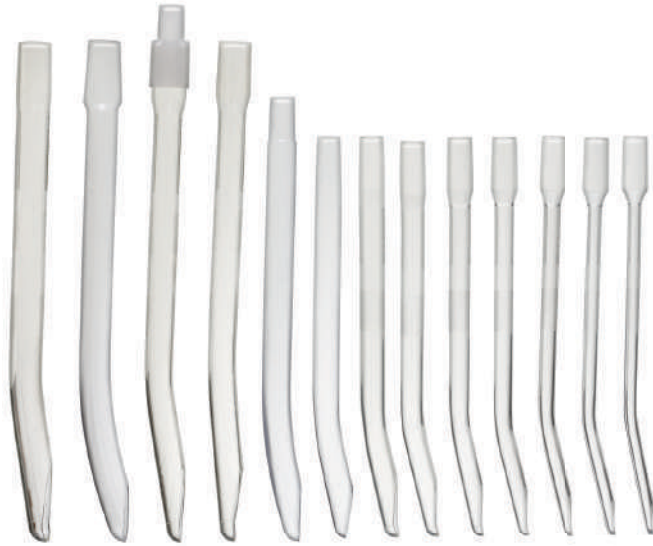

Rigid Curved Cannula-Curette

- 022106 6mm (50/Pack)
- 022107 7mm (50/Pack)
- 022108 8mm (50/Pack)
- 022109 9mm (50/Pack)
- 022110 10mm (50/Pack)
- 022111 11mm (50/Pack)
- 022112 12mm (50/Pack)
- 022113 13mm - 3/8" Base (25/Pack)
- 022114 14mm - 1/2" Base (25/Pack)
- 022144 14mm - 1/2" Base w/Adapter (25/Pack)
- 022145 14mm - 3/8" Base (25/Pack)
- 022115 15mm - 1/2" Base (25/Pack)
- 022116 16mm - 1/2" Base (25/Pack)



Rigid Straight Cannula-Curette

- 022206 6mm (50/Pack)
- 022207 7mm (50/Pack)
- 022208 8mm (50/Pack)
- 022209 9mm (50/Pack)
- 022210 10mm (50/Pack)
- 022211 11mm (50/Pack)
- 022212 12mm (50/Pack)
- 022213 13mm - 3/8" Base (25/Pack)
- 022214 14mm - 1/2" Base (25/Pack)
- 022244 14mm - 1/2" Base w/Adapter (25/Pack)
- 022245 14mm - 3/8" Base (25/Pack)
- 022215 15mm - 1/2" Base (25/Pack)
- 022216 16mm - 1/2" Base (25/Pack)



Flexible Cannula-Curette with Dual Port Design

- 022004 4mm (50/Pack)
- 022005 5mm (50/Pack)
- 022006 6mm (50/Pack)
- 022007 7mm (50/Pack)
- 022008 8mm (50/Pack)
- 022009 9mm (50/Pack)
- 022010 10mm (50/Pack)
- 022011 11mm (50/Pack)
- 022012 12mm (50/Pack)

MedGyn Double Valve Aspirator

MedGyn Double Valve Aspirator is used for uterine aspiration/uterine evacuation in obstetrics and gynecologic procedures. The device fits the MedGyn Flexible Curettes and a wide variety of MedGyn Rigid and Straight Curettes.

Specifications:

- High-quality, uncontaminated samples
- Volume: 60mL
- Vacuum: 610-660mm (24-26in) Hg

022526 MedGyn Double Valve Aspirator

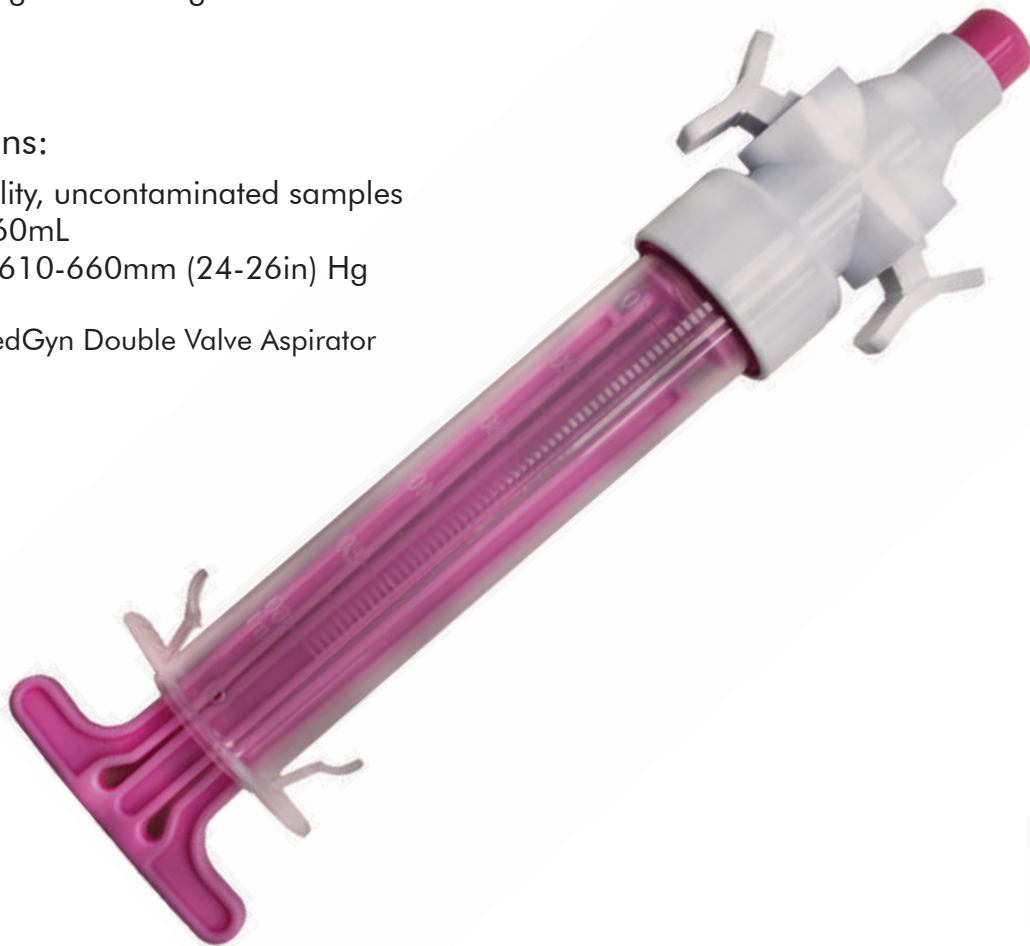

MedGyn Aspiration Kits

MedGyn Aspiration Kit and Aspiration Kit IV are effective devices for simultaneous endometrial curettage and aspiration.

- 022514 MedGyn Aspiration Kit with 4mm Cannula-Curette (10/Pack)
- 022515 MedGyn Aspiration Kit with 5mm Cannula-Curette (10/Pack)
- 022516 MedGyn Aspiration Kit with 6mm Cannula-Curette (10/Pack)
- 022517 MedGyn Aspiration Kit with 7mm Cannula-Curette (10/Pack)
- 022511 MedGyn Aspiration Kit IV with 4mm, 5mm, 6mm and 7mm Cannula-Curette (10/Pack)



MedGyn LED Speculum

MedGyn LED Speculum has a disposable cordless LED light to improve visualization of the exam area.

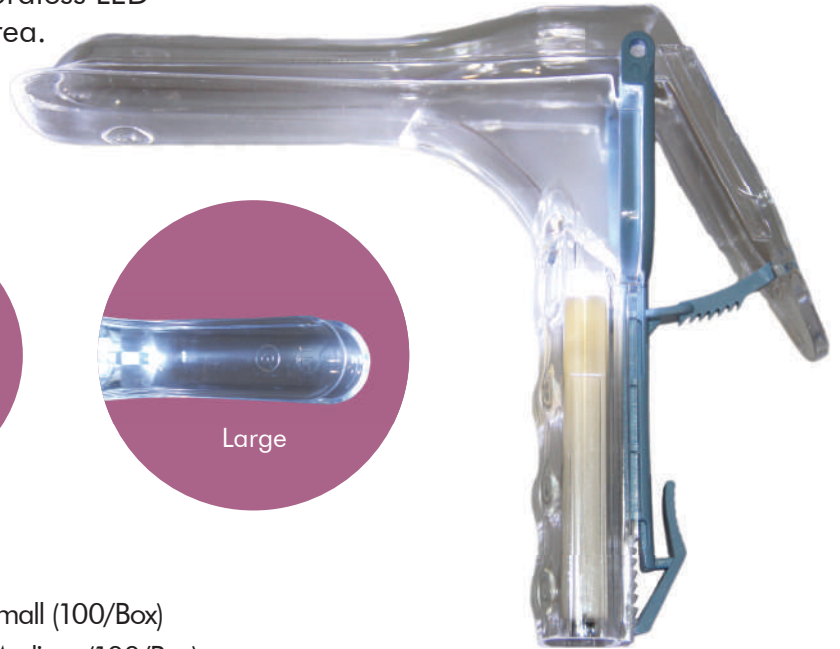

Small



Medium

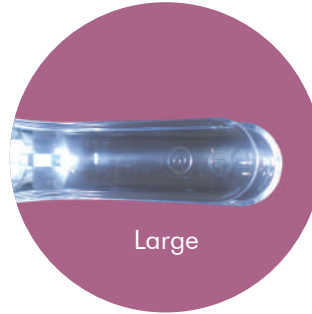

Large

- 020225 MedGyn Graves/Pederson w/ LED Small (100/Box)
- 020226 MedGyn Graves/Pederson w/ LED Medium (100/Box)
- 020227 MedGyn Graves/Pederson LED Large (80/Box)
- 020225STRL MedGyn Sterile Graves/Pederson w/ LED Small (100/Box)
- 020226STRL MedGyn Sterile Graves/Pederson w/ LED Medium (100/Box)
- 020227STRL MedGyn Sterile Graves/Pederson w/ LED Large (80/Box)

MedGyn Vaginal Speculum (Non-Sterile)

MedGyn Disposable Speculum is available in both Graves and Pederson styles and easily locks in a variety of positions to reduce examination time.



Small



Medium



Large

- 020201 MedGyn Disposable Pederson Small (100/Box)
- 020204 MedGyn Disposable Graves Medium (100/Box)
- 020205 MedGyn Disposable Graves Large (100/Box)

MedGyn Uterine Manipulator

This device is used for hysterectomy, laparoscopic tubal occlusion, diagnostic laparoscopy, mini laparotomy, salpingoplasty and fertility exams.

- Depth markings every centimeter assure a correct insertion depth
- Sturdy handle is anatomically curved to create better insertion maneuverability and manipulation
- Smaller cannula size allows for easier insertion
- Unique pear-shaped balloon provides a secure seal of the internal os

**Snap-on
Handle**



**Pinch grip
Handle**



022701 MedGyn Uterine Manipulator (12/Box)

*Equivalent to TMI1151

022700 MedGyn K-UMI Uterine Manipulator (12/Box)

*Equivalent to TMI6003

MedGyn Dilasound

A strong yet flexible, single-use, double-ended device designed for gentle cervical dilation and accurate uterine depth assessment.

- Smooth, rounded tips minimize risk of perforation
- Clear 1cm depth markings for precise measurement
- Built-in safety stop 100mm from the stem to help prevent uterine perforation
- Dilator arm offers dilation from 3.5mm to 4.5mm to 5.0mm to 5.5mm over a length of 100mm

020251 MedGyn Dilasound

MedGyn Uterine Sounds

MedGyn Disposable Uterine Sounds are made of malleable plastic with centimeter graduations for accurate measurement of uterine cavity.

020250 MedGyn Disposable Uterine Sounds
O.D. 3mm 10" Length with Marking
(25/Box)

MedGyn Os Finders

Ideal for cervical dilation, uterine sounding or other intrauterine procedures. Made of semi-flexible plastic and packaged individually sterile.

- Made of smooth, malleable plastic
- Enhances procedural efficiency
- Disposable to ensure safety and lower cost of re-sterilization procedures

022731 MedGyn Disposable Os Finder (50/Pack)

022735 MedGyn Disposable Fundus Finder

OS-01-050 MedGyn Disposable Canal Finder 



020251 020250 022731 022735 OS-01-050

MedGyn Single-Use Pratt/Denniston Dilators

- Gentle, reliable cervical dilation with durable, medical-grade plastic
- Smooth tapered tips designed for comfort, control, and dependable performance in gynecologic procedures
- Available in single-use and a reusable 5 piece set (030890)

023790-D Pratt / Denniston Single-use Plastic Dilator
5/6mm

023791-D Pratt / Denniston Single-use Plastic Dilator
7/8mm

023792-D Pratt / Denniston Single-use Plastic Dilator
9/10mm



MedGyn Word Bartholin Catheter

For use following an incision and drainage of a Bartholin's cyst or abscess. Catheter kit includes balloon catheter, syringe for balloon inflation and scalpel.

- Minimally invasive
- Improved patient comfort
- Reduces recurrence risk

022719 MedGyn Word Bartholin Catheter (6/Box)

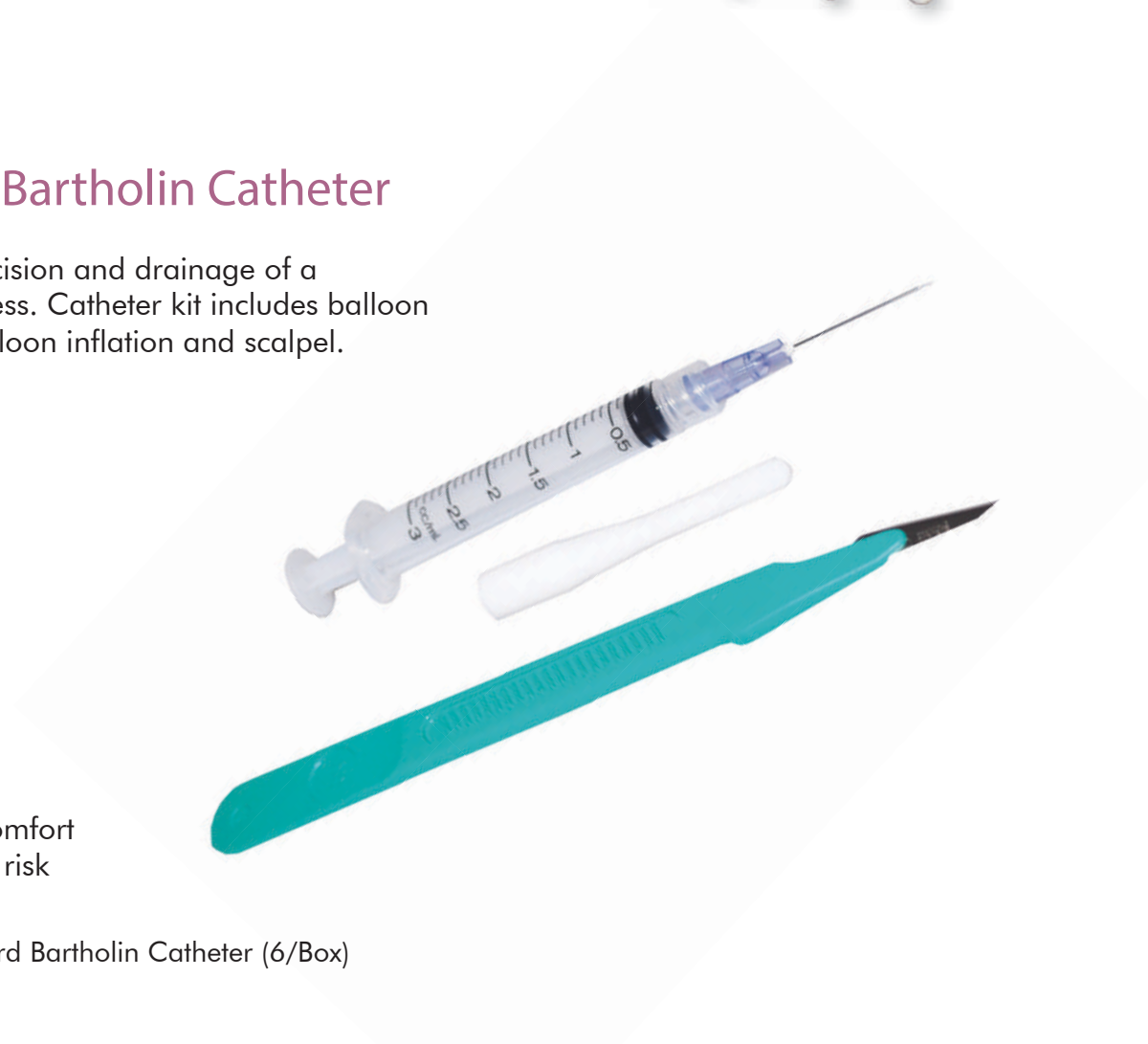

MedGyn IUD Retrieval Hook

MedGyn's IUD Retrieval Hook is designed to assist in the removal of the intrauterine device from the uterus.



022366 Disposable IUD Retrieval Hook (25/Box)

MedGyn's Disposable Derma Curette

022797-2 Disposable Derma Curette 2.0mm

022797-3 Disposable Derma Curette 3.0mm

022797-4 Disposable Derma Curette 4.0mm

022797-5 Disposable Derma Curette 5.0mm

022797-7 Disposable Derma Curette 7.0mm



MedGyn's Disposable Derma (Keyes Biopsy) Punch

MedGyn's latest products include a disposable derma (keyes biopsy) punch made of quality stainless steel and a ribbed sturdy handle for the ejection of lodged specimen.

022727-1 Disposable Derma (Keyes Biopsy) Punch 1mm

022727-2 Disposable Derma (Keyes Biopsy) Punch 2mm

022727-3 Disposable Derma (Keyes Biopsy) Punch 3mm

022727-4 Disposable Derma (Keyes Biopsy) Punch 4mm

022727-5 Disposable Derma (Keyes Biopsy) Punch 5mm

022727-6 Disposable Derma (Keyes Biopsy) Punch 6mm

022727-7 Disposable Derma (Keyes Biopsy) Punch 7mm

022727-8 Disposable Derma (Keyes Biopsy) Punch 8mm



MedGyn's Disposable Scalpel

MedGyn's latest products include disposable scalpels made of quality stainless steel blades with sturdy, non-slip plastic handles.

022798-11 Disposable Scalpel #11

022798-15 Disposable Scalpel #15



MedGyn Needle Extender

An effective means of extending ordinary hypodermic needles when longer needles are required.

022600 MedGyn Disposable Needle Extender



MedGyn Pregnancy Test Kits

MedGyn One-Step Pregnancy Test Kit is an easy-to-use clinical pregnancy test that delivers fast and accurate results. Our tests have built-in test controls and highly visible color.



022706

- 022704 MedGyn Pregnancy HCG Cassette Urine Test (25/Box)
- 022705 MedGyn Pregnancy HCG Combo Urine/Serum Test (25/Box)
- 022706 MedGyn Pregnancy HCG Dipstick Urine Test (25/Box)

MedGyn Cervical Cerclage Tape

MedGyn Cervical Cerclage Tape offers clinicians the reliability and support needed in cervical cerclage procedures

- Excellent durability with resistance to breakage
- Ease of removal when no longer required
- Convenient design with round-bodied needles attached at each end

020330 MedGyn Cervical Cerclage Tape
*International Only



MedGyn Amnio Hook

MedGyn Amnio Hook is designed to perforate the amniotic membrane with a rigid talon tip.

- Sterile, single-use device
- Designed for the safe and precise artificial rupture of membranes during labor
- Protects against cross contamination and reduces the possibility of infection
- 25cm long

020301 MedGyn Disposable Amnio Hook (50/Pack)

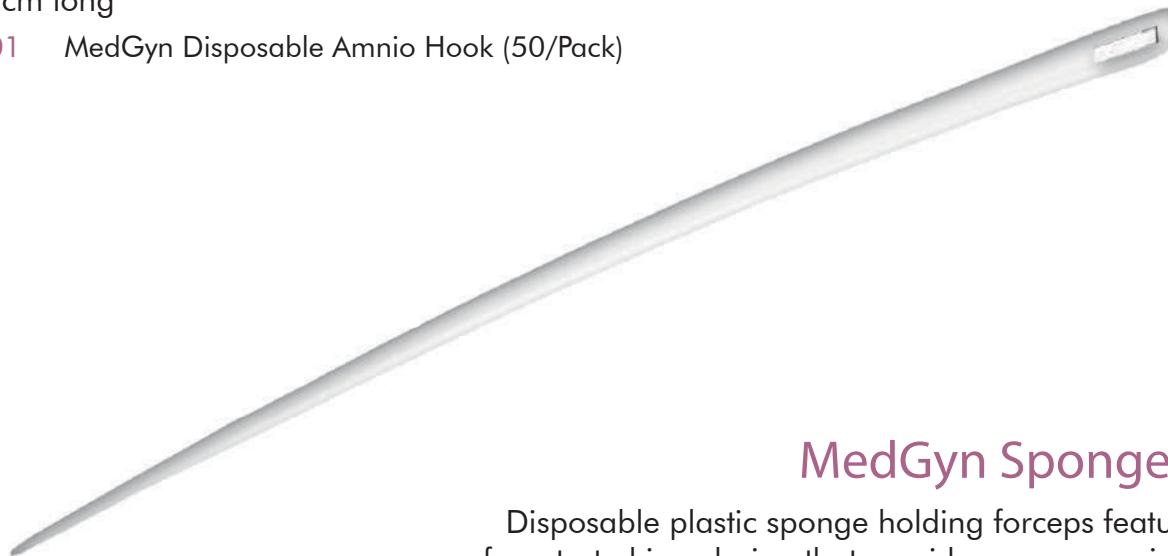

020301

MedGyn Sponge Forceps

Disposable plastic sponge holding forceps feature a tapered, fenestrated jaw design that provides a secure grip on sponges. The ratcheted finger ring locking mechanism ensures a firm hold on gauze, while the serrated, precisely aligned jaws deliver reliable control and performance.

022795-D Sponge Holding Forceps 17mm x 250mm length



022795-D

MedGyn Umbilical Cord Clamp

MedGyn Umbilical Cord Clamp has grooved clamping and lock to secure the umbilical cord prior to cutting.

- Grooved clamping to prevent slipping of the umbilical cord
- Locks to prevent accidental opening after clamping
- Safe and convenient for handling

020302 MedGyn Disposable Umbilical Cord Clamp (100/Pack)



020302

MedGyn Silicone Pessaries

Pessaries provide effective, non-surgical treatment for pelvic support defects and stress urinary incontinence. MedGyn offers a wide range of medical-grade, latex-free silicone pessaries and easy-to-use fitting sets.

Pessary Fitting Sets:

MedGyn offers autoclavable Fitting Sets in varying shapes and sizes to accommodate any patient.



051001 MedGyn Pessary Case
(28 different pessaries
including Ring Fitting Set)



051000 Ring w/o Support
Pessary Fitting Set
Sizes: 1-6



051005 Ring w/ Support
Pessary Fitting Set
Sizes: 2-7



051007 Ring with Knob
Pessary Fitting Set
Sizes: 2-7



051009 Cube
Pessary Fitting Set
Sizes: 0-5



051010 Cube with Drain
Pessary Fitting Set
Sizes: 0-5



051011 Donut
Pessary Fitting Set
Sizes: 1-6



051012 Gellhorn Drain
Pessary Fitting Set
Sizes: 1-6



051013 Gellhorn Short Stem
Pessary Fitting Set
Sizes: 1-6



051006 Shaatz
Pessary Fitting Set
Sizes: 2-7

051008 Dish w/ Knob
Pessary Fitting Set
Sizes: 2-7



Ring with Support			
Product #	Size	in.	mm
050026	#1	2	51
050027	#2	2½	57
050028	#3	2¾	62
050029	#4	2¾	70
050030	#5	2¾ ₁₀	74
050031	#6	3½	82
050032	#7	3½	89
050033	#8	3¾	96
050034	#9	4	102

Ring w/o Support			
Product #	Size	in.	mm
050017	#1	2	51
050018	#2	2½	57
050019	#3	2¾	62
050020	#4	2¾	70
050021	#5	2¾ ₁₀	74
050022	#6	3½	82
050023	#7	3½	89
050024	#8	3¾	96
050025	#9	4	102



Ring with Knob & Support			
Product #	Size	in.	mm
050026K	#1	2	51
050027K	#2	2½	57
050028K	#3	2½	63
050029K	#4	2½	70
050030K	#5	3	76
050031K	#6	3¾ ₁₀	83
050032K	#7	3½	89

Ring with Knob & w/o Support			
Product #	Size	in.	mm
050017K	#1	2	51
050018K	#2	2½	57
050019K	#3	2½	63
050020K	#4	2¾	70
050021K	#5	3	76
050022K	#6	3¾ ₁₀	83
050023K	#7	3½	89



Marland with Support			
Product #	Size	in.	mm
050084	#2	2¼	57
050085	#3	2½	63
050086	#4	2¾	70
050087	#5	3	76
050088	#6	3¼	83
050089	#7	3½	89
050090	#8	3¾	95

Marland w/o Support			
Product #	Size	in.	mm
050077	#2	2¼	57
050078	#3	2½	63
050079	#4	2¾	70
050080	#5	3	76
050081	#6	3¼	83
050082	#7	3½	89
050083	#8	3¾	95



Modified Cup with Drain Cerclage (International only)			
Product #	Size	in.	mm
050210M	#1	2½	65/32/21
050211M	#2	2¾	70/32/21
050212M	#3	2½	65/35/21
050213M	#4	2¾	70/35/21
050214M	#5	2½	65/35/30
050215M	#6	2¾	70/35/30

Modified Cup w/o Drain Cerclage (International only)			
Product #	Size	in.	mm
050191M	#1	2½	65/32/21
050192M	#2	2¾	70/32/21
050193M	#3	2½	65/35/21
050194M	#4	2¾	70/35/21
050195M	#5	2½	65/35/30
050196M	#6	2¾	70/35/30

*Cerclage pessaries do not include "M" in product ID#



Gellhorn with Drain							
Product #	Size	in.	mm	Product #	Size	in.	mm
050155	#1	1 $\frac{7}{10}$	44	050159	#5	2 $\frac{4}{5}$	70
050156	#2	2	51	050160	#6	3	76
050157	#3	2 $\frac{1}{5}$	57	050161	#7	3 $\frac{1}{5}$	82
050158	#4	2 $\frac{1}{2}$	63	050162	#8	3 $\frac{1}{2}$	89



Gellhorn Short Stem							
Product #	Size	in.	mm	Product #	Size	in.	mm
050155S	#1	1 $\frac{3}{4}$	44	050159S	#5	2 $\frac{3}{4}$	70
050156S	#2	2	51	050160S	#6	3	76
050157S	#3	2 $\frac{1}{5}$	57	050161S	#7	3 $\frac{1}{4}$	82
050158S	#4	2 $\frac{1}{2}$	63	050162S	#8	3 $\frac{1}{2}$	89

Stem Height 28 mm, 1.1 in



Donut							
Product #	Size	in.	mm	Product #	Size	in.	mm
050010	#0	2	51	050014	#4	3	76
050011	#1	2 $\frac{1}{5}$	57	050015	#5	3 $\frac{1}{5}$	82
050012	#2	2 $\frac{1}{2}$	64	050016	#6	3 $\frac{1}{2}$	88
050013	#3	2 $\frac{7}{10}$	69	050199	#7	3 $\frac{7}{10}$	95



Shatz with Drain							
Product #	Size	in.	mm	Product #	Size	in.	mm
050120	#0	1 $\frac{1}{2}$	38	050125	#5	2 $\frac{4}{5}$	70
050121	#1	1 $\frac{3}{4}$	44	050126	#6	3	76
050122	#2	2	51	050127	#7	3 $\frac{1}{5}$	82
050123	#3	2 $\frac{1}{5}$	57	050128	#8	3 $\frac{1}{2}$	88
050124	#4	2 $\frac{1}{2}$	64				



Cup with Support			
Product #	Size	in.	mm
050171	#0	1 ⁴ / ₅	48
050172	#1	2	52
050173	#2	2 ¹ / ₄	57
050174	#3	2 ¹ / ₂	63
050175	#4	2 ⁷ / ₁₀	68
050176	#5	2 ⁹ / ₁₀	73
050177	#6	3	77
050178	#7	3 ¹ / ₅	82

Cup w/o Support			
Product #	Size	in.	mm
050163	#0	1 ⁴ / ₅	48
050164	#1	2	52
050165	#2	2 ¹ / ₄	57
050166	#3	2 ¹ / ₂	63
050167	#4	2 ⁷ / ₁₀	68
050168	#5	2 ⁹ / ₁₀	73
050169	#6	3	77
050170	#7	3 ¹ / ₅	82



Gehung with Support							
Product #	Size	in.	mm	Product #	Size	in.	mm
050145	#0	2	50	050150	#5	3	75
050146	#1	2 ¹ / ₅	55	050151	#6	3 ¹ / ₅	80
050147	#2	2 ² / ₅	60	050152	#7	3 ² / ₅	85
050148	#3	2 ³ / ₅	65	050153	#8	3 ³ / ₅	90
050149	#4	2 ⁴ / ₅	70				



Cube with Drain			
Product #	Size	in.	mm
050066	#0	4 ⁹ / ₅₀	25
050067	#1	1 ¹ / ₁₀	29
050068	#2	1 ¹ / ₅	32
050069	#3	1 ² / ₅	36
050070	#4	1 ³ / ₅	40
050071	#5	1 ⁴ / ₅	45
050072	#6	1 ⁹ / ₁₀	49
050073	#7	2 ¹ / ₅	55
050074	#8	2 ¹ / ₂	63
050075	#9	2 ⁷ / ₁₀	69
050076	#10	2 ⁹ / ₁₀	74

Cube w/o Drain			
Product #	Size	in.	mm
050055	#0	4 ⁹ / ₅₀	25
050056	#1	1 ¹ / ₁₀	29
050057	#2	1 ¹ / ₅	32
050058	#3	1 ² / ₅	36
050059	#4	1 ³ / ₅	40
050060	#5	1 ⁴ / ₅	45
050061	#6	1 ⁹ / ₁₀	49
050062	#7	2 ¹ / ₅	55
050063	#8	2 ¹ / ₂	63
050064	#9	2 ⁷ / ₁₀	69
050065	#10	2 ⁹ / ₁₀	74



Hodge with Support			
Product #	Size	in.	mm
050045	#0	2 ³ / ₅	65
050046	#1	2 ⁴ / ₅	70
050047	#2	3	75
050048	#3	3 ¹ / ₅	80
050049	#4	3 ² / ₅	85
050050	#5	3 ³ / ₅	90
050051	#6	3 ⁴ / ₅	95
050052	#7	4	100
050053	#8	4 ¹ / ₅	105
050054	#9	4 ² / ₅	110

Hodge w/o Support			
Product #	Size	in.	mm
050035	#0	2 ³ / ₅	65
050036	#1	2 ⁴ / ₅	70
050037	#2	3	75
050038	#3	3 ¹ / ₅	80
050039	#4	3 ² / ₅	85
050040	#5	3 ³ / ₅	90
050041	#6	3 ⁴ / ₅	95
050042	#7	4	100
050043	#8	4 ¹ / ₅	105
050044	#9	4 ² / ₅	110



Oval with Support			
Product #	Size	in.	mm
050111	#1	2	51
050112	#2	2 ¹ / ₄	57
050113	#3	2 ¹ / ₂	64
050114	#4	2 ⁷ / ₁₀	69
050115	#5	3	76
050116	#6	3 ¹ / ₄	83
050117	#7	3 ¹ / ₂	89
050118	#8	3 ³ / ₄	95
050119	#9	4	102

Oval w/o Support			
Product #	Size	in.	mm
050101	#1	2	51
050102	#2	2 ¹ / ₄	57
050103	#3	2 ¹ / ₂	64
050104	#4	2 ⁷ / ₁₀	69
050105	#5	3	76
050106	#6	3 ¹ / ₄	83
050107	#7	3 ¹ / ₂	89
050108	#8	3 ³ / ₄	95
050109	#9	4	102



Dish with Support			
Product #	Size	in.	mm
050137	#0	2	50
050138	#1	2 ¹ / ₅	55
050139	#2	2 ² / ₅	60
050140	#3	2 ¹ / ₂	63
050141	#4	2 ⁷ / ₁₀	68
050142	#5	2 ⁹ / ₁₀	73
050143	#6	3 ¹ / ₁₀	80
050144	#7	3 ³ / ₁₀	85

Dish w/o Support			
Product #	Size	in.	mm
050129	#0	2	50
050130	#1	2 ¹ / ₅	55
050131	#2	2 ² / ₅	60
050132	#3	2 ¹ / ₂	63
050133	#4	2 ⁷ / ₁₀	68
050134	#5	2 ⁹ / ₁₀	73
050135	#6	3 ¹ / ₁₀	80
050136	#7	3 ³ / ₁₀	85

Overview of MedGyn's Pessary Types and Uses

Pessary	1st-2nd Degree	2nd-3rd Degree	Sexually Active	Vaginal Wall	Stress Urinary Incontinence	Cystocele	Rectocele	Incompetent Cervix
Cube		X	X	X	X	X	Mild X	
Cup with Support	X							
Modified Cup		X				X		X
Donut		X				Mild X		
Dish with Support	X				X	Mild X		
Gellhorn		X				Mild X		
Oval with Support	X					X		
Ring	X		X					
Ring with Support	X		X			Mild X		
Ring with Knobbed	X		X		X	Mild X		
Ring with Knobbed & Support	X		X		X	Mild X		
Shatz with Drain	X					Mild X		
Marland with Support		X				X	X	
Marland without Support		X				X	X	
Hodge with Support	X					X		
Hodge without Support	X					X		

MedGyn Pessary Remover

Designed to aid in the removal of several types of pessaries. The firm grip and flexibility allows patients to safely and easily remove their own pessaries. The high-quality plastic is not cold, unlike metal removers, greatly increasing patient comfort.

031315 Pessary Remover



MedGyn Speculums

Graves Speculum
Wider blade design



- 030905 XSmall 3/4" x 2 3/4" (19mm x 70mm)
- 030901 Small 3/4" x 3" (19mm x 76mm)
- 030902 Medium 1 3/8" x 4" (35mm x 102mm)
- 030903 Large 1 3/8" x 4 3/4" (35mm x 121mm)
- 030904 XLarge 1 1/2" x 6 1/2" (38mm x 165mm)
- 030900 Extra Long Snowman Clinton 1 1/2" x 6" (38mm x 152mm)

Graves Vu-More Speculum
Wider blade design with larger view area (4cm vs. standard 3cm).



- 030952 Small 3 3/4" (95mm)
- 030953 Medium 4 1/2" (114mm)
- 030954 Large 5" (127mm)
- 030955 XLong 6" (152mm)
- 030956 XLong 6 1/3" (161mm)
- 030957 XLong 6 3/4" (171mm)
- 030958 XLong 7" (178mm)

Graves Vu-More Speculum
Wider blade design with larger view area (4cm vs. standard 3cm) with durable coating.



- 030985 Medium 4 1/2" (114mm)
- 030986 Large 5" (127mm)

Graves Vu-Max Speculum
Wider blade design with largest view area (7cm vs. standard 3cm) with durable coating.



- 030987 Medium 4 1/2" (114mm)
- 030988 Large 5" (127mm)

Graves Vu-Max Speculum
Wider blade design with largest view area (7cm vs. standard 3cm).



- 030975 Medium 4 1/2" (114mm)
- 030976 Large 5" (127mm)
- 030977 XLong 6" (152mm)
- 030978 XLong 6 1/3" (161mm)
- 030979 XLong 6 3/4" (171mm)
- 030980 XLong 7" (178mm)

Graves Speculum

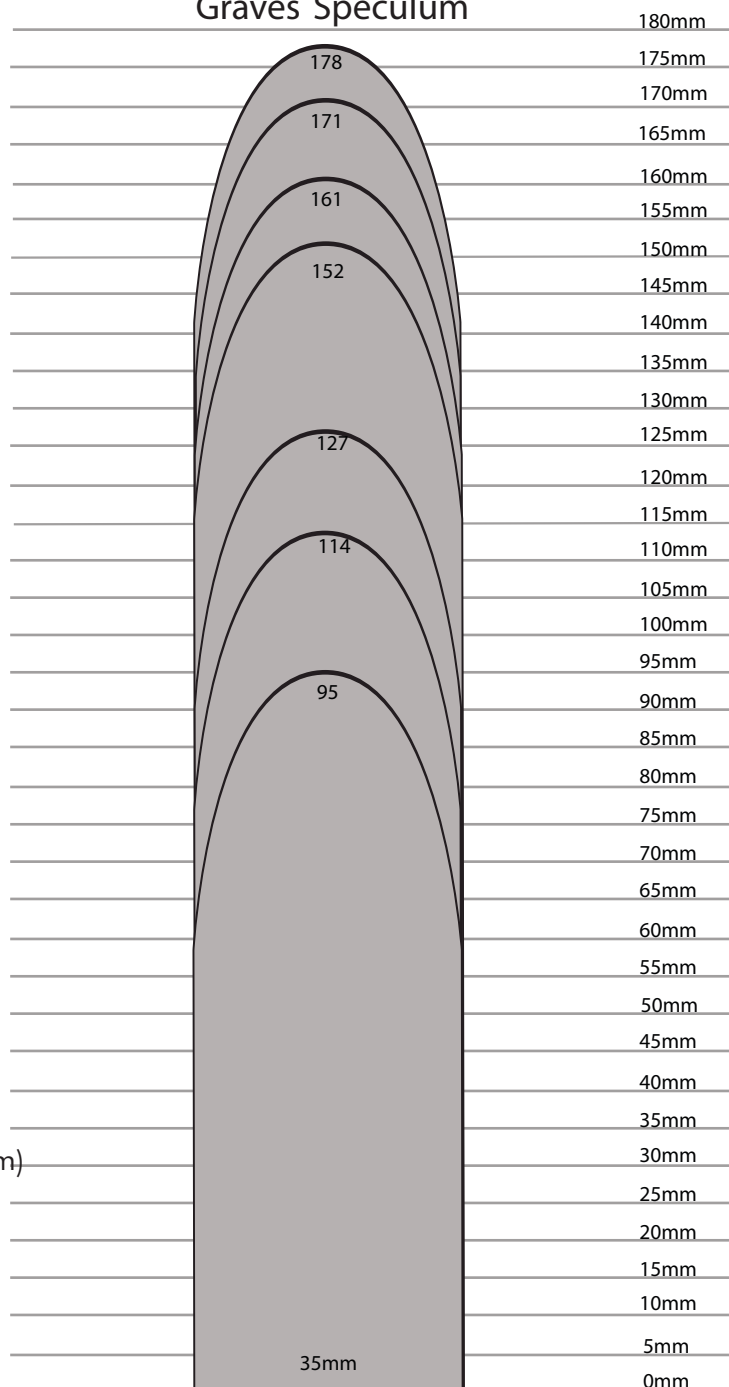

Moore Graves Speculum

Short blade design



030920 1 1/4" x 3 1/2" (32mm x 89mm)

Weisman Graves Speculum

Open-side speculum



030911-SM Small - Right 3/8" x 3" (10mm x 76mm)

030911 Medium - Right 1 3/8" x 4" (35mm x 102mm)

030911-LG Large - Right 1 3/8" x 4 3/4" (35mm x 121mm)

030911-XL XLarge - Right 1 1/2" x 6 1/2" (38mm x 165mm)

030912 Medium - Left 1 3/8" x 4" (35mm x 102mm)

030912-LG Large - Left 1 3/8" x 4 3/4" (35mm x 121mm)

030912-XL XLarge - Left 1 1/2" x 6 1/2" (38mm x 165mm)

Graves Speculum

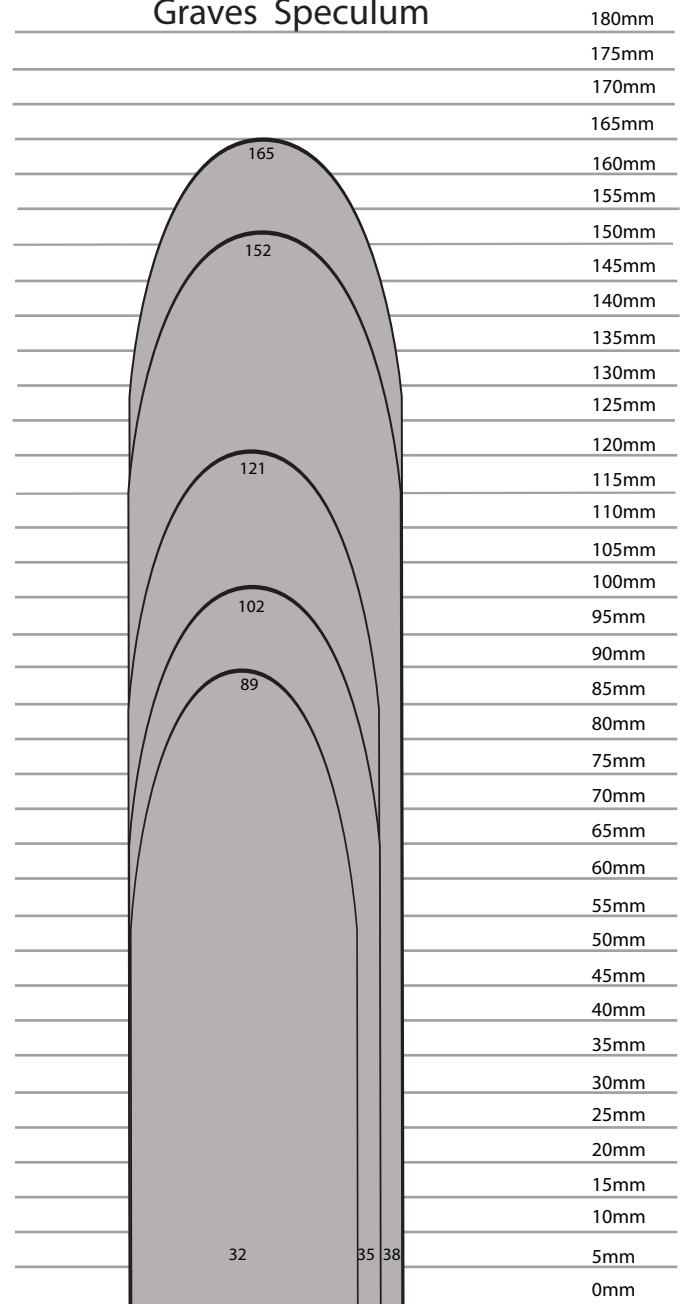

Graves Wide Angled Speculum

Wider Graves blade design with 45° open angle.



030909 Medium 1 3/8" x 4" (35mm x 102mm)

030910 Right Side Open Medium 1 3/8" x 4" (35mm x 102mm)

030971 Right Side Open Large 1 3/8" x 4 3/4" (35mm x 121mm)

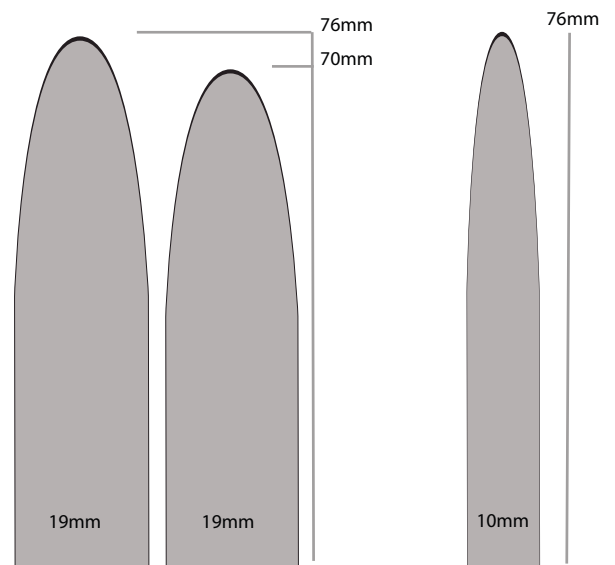

Pederson Speculum

Narrow blade design



- 030941 XNarrow 5/8" x 4" (17mm x 102mm)
- 030913 XSmall 1/2" x 2 3/4" (13mm x 70mm)
- 030906 Small 1/2" x 3" (13mm x 76mm)
- 030907 Medium 7/8" x 4" (22mm x 102mm)
- 030908 Large 1" x 4 3/4" (25mm x 121mm)
- 030914 XLarge 1" x 6 1/2" (25mm x 165mm)
- 030917 Extra Long Snowman Clinton 1" x 6" (25mm x 152mm)

Pederson - Open Side Speculum

Narrow blade design with open side



- 030972 45° Medium - Right 7/8" x 4" (22mm x 102mm)
- 030973 45° Large - Right 1" x 4 3/4" (25mm x 121mm)
- 030942 XNarrow - Right 5/8" x 4" (17mm x 102mm)
- 030943 XNarrow - Left 5/8" x 4" (17mm x 102mm)
- 030939 Medium - Right 7/8" x 4" (22mm x 102mm)
- 030939-LT Medium - Left 7/8" x 4" (22mm x 102mm)
- 030908R Large - Right 1" x 4 3/4" (25mm x 121mm)
- 030908-LT Large - Left 1" x 4 3/4" (25mm x 121mm)
- 030914-L-XL XLarge - Left 1" x 6 1/2" (25mm x 165mm)
- 030914-R-XL XLarge - Right 1" x 6 1/2" (25mm x 165mm)

Pederson Vu-More Speculum

Larger view area (4cm vs. standard 3cm) with durable coating.



- 030981 Medium 4 1/2" (114mm)
- 030982 Large 5" (127mm)

Pederson Speculum

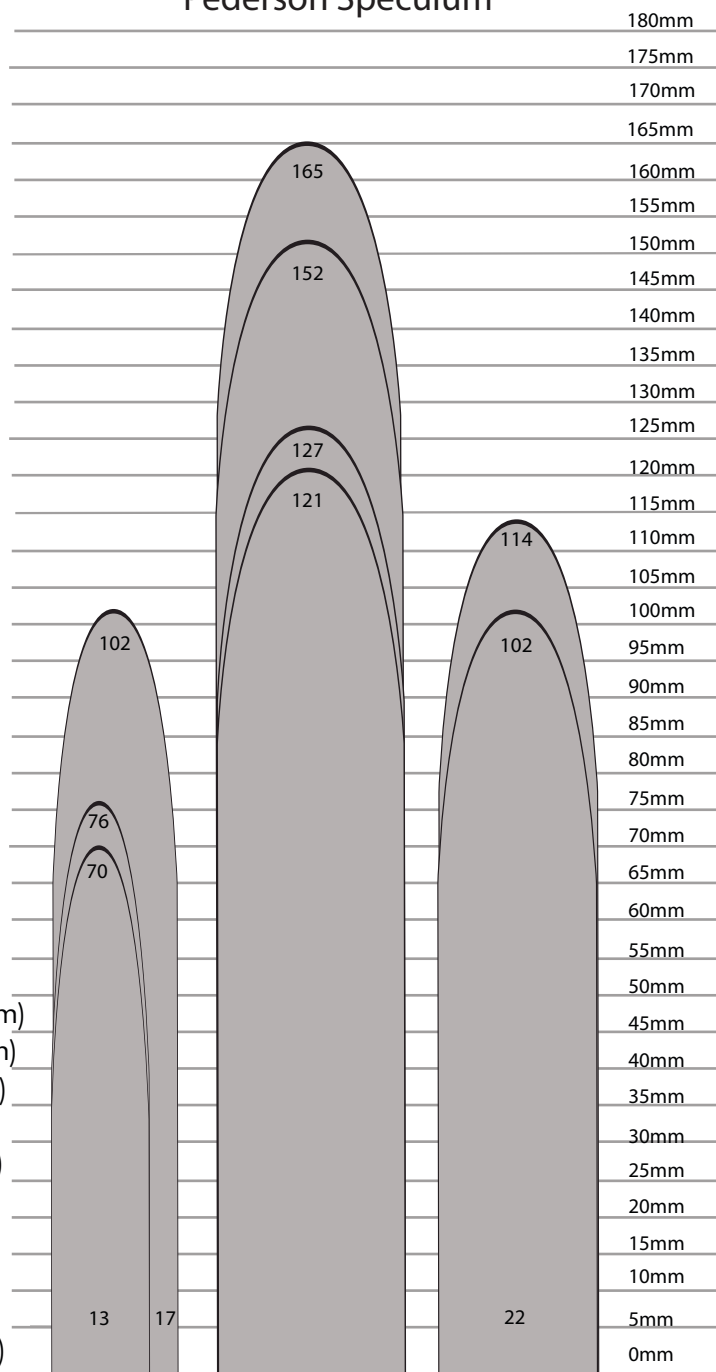

Pederson Vu-Max Speculum

Largest view area (7cm vs. standard 3cm) with durable coating.



- 030983 Medium 4 1/2" (114mm)
- 030984 Large 5" (127mm)

Klopfers Speculum

Wider opening (4cm) and short blade



030931 1 3/8" x 3 1/2" (35mm x 89mm)

Cusco Speculum

Unique handle-design speculum with center screw or side screw options.



- 030960 Small w/Center Screw 1 1/3" x 3 1/2" (34mm x 89mm)
- 030961 Medium w/Center Screw 1 3/8" x 4" (35mm x 102mm)
- 030962 Large w/Center Screw 1 3/8" x 4 1/2" (35mm x 114mm)
- 030963 Small w/Side Screw 1 1/3" x 3 1/2" (34mm x 89mm)
- 030964 Medium w/Side Screw 1 3/8" x 4" (35mm x 102mm)
- 030965 Large w/Side Screw 1 3/8" x 4 1/2" (35mm x 114mm)

Four-Way Speculum

Combines the characteristics of both a standard speculum and a vaginal wall retractor.



- 038095 4-Way Lateral Expander Speculum - Medium 7/8" x 4 1/4" (22mm x 108mm)
- 038096 4-Way Lateral Expander Speculum - Large 7/8" x 5 1/4" (22mm x 133mm)

Grundman Speculum

Wide open design with screw adjustment/lever



- 030949 Small 1 1/3" x 3 1/3" (34mm x 85mm)
- 030950 Medium 1 3/8" x 3 3/4" (35mm x 95mm)
- 030951 Large 1 1/2" x 4 3/4" (38mm x 121mm)

Klopfers, Grundman, Cusco, Four-Way Speculum

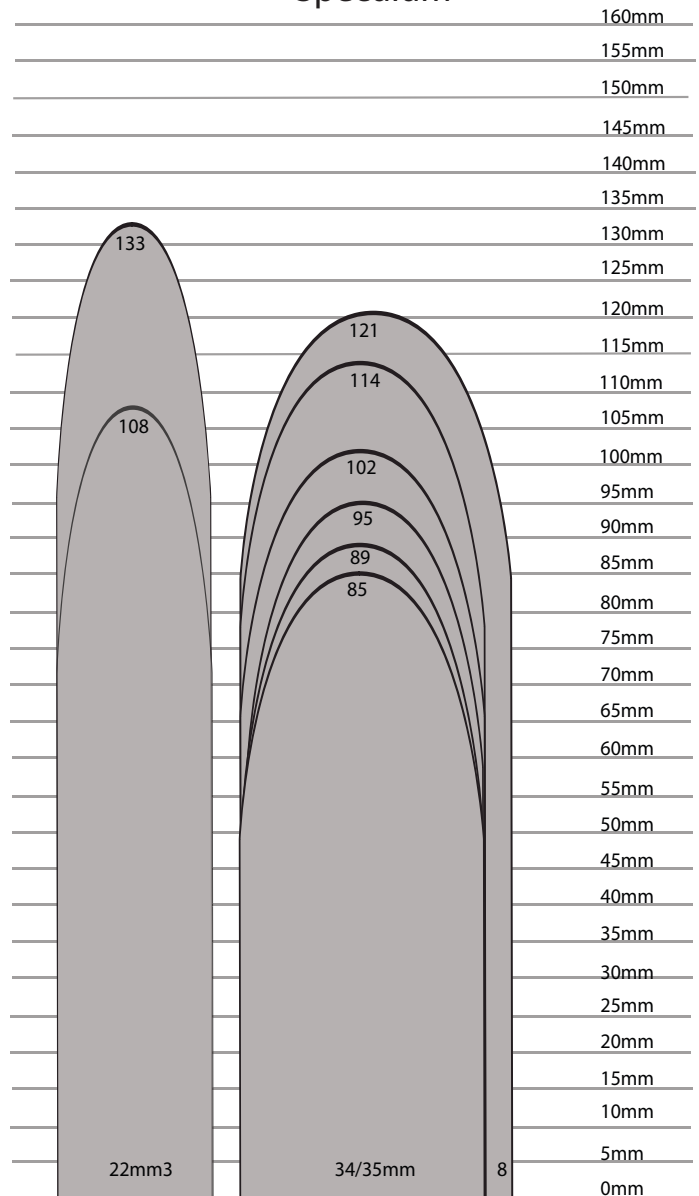

Weighted Speculum



- 030921 Auvar 2.0lbs, 75° angle, Blade 1 1/2" x 3 1/4" (38mm x 83mm)
- 030922 Auvar 2.5lbs, 75° angle, Blade 1 1/2" x 3 1/4" (38mm x 83mm)
- 030923 Auvar 3.0lbs, 75° angle, Blade 1 1/2" x 3 1/4" (38mm x 83mm)
- 030924 Auvar 2.5lbs, 45° angle, Blade 1 3/8" x 4" (35mm x 102mm)
- 030926 Auvar 2.5lbs, 90° angle, Blade 1" x 5 1/2" (25mm x 140mm)

Collins Speculum

Unique hands-free design offers the advantages of an open-sided speculum while permitting multiple positioning for optimal exposure with blades that open laterally instead of vertically.

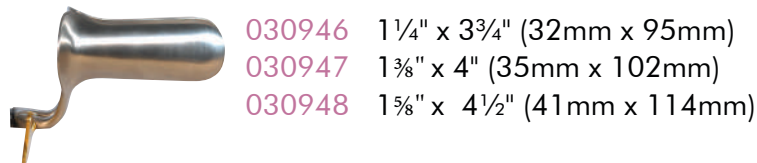

- 030946 1 ¼" x 3 ¾" (32mm x 95mm)
- 030947 1 ⅜" x 4" (35mm x 102mm)
- 030948 1 ⅝" x 4 ½" (41mm x 114mm)

Sims Vaginal Speculum 3 Piece Set

- Double-ended, smooth, curved blade
- Capable of 360-degree rotation for enhanced visualization



- 030932 Sims Vaginal Speculum 3 Piece Set
- 030933 Sims Vaginal Speculum 65 x 25mm, 70 x 30mm
- 030934 Sims Vaginal Speculum 70 x 30mm, 70 x 35mm
- 030935 Sims Vaginal Speculum 85 x 35mm, 90 x 40mm

Lateral Vaginal Wall Retractor

Used for the retraction of vaginal lateral wall and made to fit inside any standard speculum to expand past blades of speculum. Allows for greater exposure of cervix for safer, more accurate procedures.



- 030970 Lateral Vaginal Wall Retractor Blue Titanium
- 030966 Open ½" (13mm), 10" (254mm), Blade Size 1" x 2 ½" (25mm x 64mm)
- 030967 Open 1" (25mm), 10" (254mm), Blade Size 1" x 2 ½" (25mm x 64mm)
- 030968 Wide Open, 10" (254mm), Blade Size 1" x 2 ½" (25mm x 64mm)
- 030969 Closed, 10" (254mm), Blade Size 1" x 2 ½" (25mm x 64mm)

Endocervical Speculum



- 030205 Endocervical Speculum Blue Titanium
- 030915 Kogan with Screw 2-4mm
- 030916 Kogan with Screw 4-8mm
- 030201 Kogan with Gauge & Ratchet 2-4mm
- 030202 Kogan with Gauge & Ratchet 4-8mm
- 030203 Kogan with Gauge & Ratchet 8-12mm
- 030204 Townsend Endocervical Speculum 8-12mm

Collins Speculum

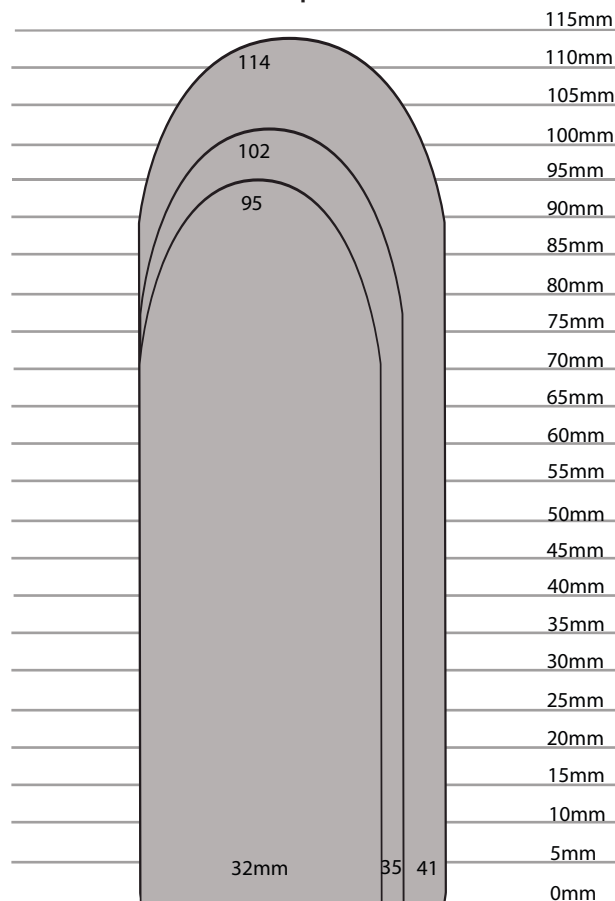

MedGyn LLETZ Instruments - Blue Coated

All MedGyn LLETZ instruments have a durable coating to insulate against transmission of electric current, ensuring the highest level of protection for patients and physicians.

Graves Speculum Closed Tube

- 038030 Small, $\frac{3}{4}$ " x 3" (19mm x 76mm)
- 038031 Medium, $1\frac{3}{8}$ " x 4" (35mm x 102mm)
- 038032 Large, $1\frac{3}{8}$ " x $4\frac{3}{4}$ " (35mm x 121mm)
- 038033 Extra Large, $1\frac{1}{2}$ " x $6\frac{1}{2}$ " (38mm x 165mm)
- 030900-LTZ Extra Long Snowman, Clinton $1\frac{1}{2}$ " x 6" (38mm x 152mm)



Graves Vu-More Speculum Closed Tube

- 038055 Medium $1\frac{1}{4}$ " x 4" (32mm x 102mm)
- 038056 Large $1\frac{3}{8}$ " x $4\frac{1}{2}$ " (35mm x 114mm)



Graves Vu-Max Speculum Closed Tube

- 038046 Large $1\frac{3}{8}$ " x $4\frac{1}{2}$ " (35mm x 114mm)



Graves Vu-More Speculum, (40mm) Open Channel

- 038115 Small $3\frac{7}{8}$ " (98mm)
- 038116 Medium $4\frac{1}{2}$ " (114mm)
- 038117 Large $4\frac{7}{8}$ " (124mm)
- 038118 Extra Large $5\frac{7}{8}$ " (149mm)
- 038119 Extra Large $6\frac{1}{3}$ " (161mm)
- 038120 Extra Large $6\frac{2}{3}$ " (169mm)
- 038121 Extra Large 7" (178mm)



Graves Vu-Max Speculum, (70mm) Open Channel

- 038125 Small 3 $\frac{7}{8}$ " (98mm)
- 038126 Medium 4 $\frac{1}{2}$ " (114mm)
- 038127 Large 4 $\frac{7}{8}$ " (124mm)
- 038128 Extra Large 5 $\frac{7}{8}$ " (149mm)
- 038129 Extra Large 6 $\frac{1}{3}$ " (161mm)
- 038130 Extra Large 6 $\frac{2}{3}$ " (169mm)
- 038131 Extra Large 7" (178mm)



Pederson Speculum Closed Tube

- 038040 Small, 1/2" x 3" (13mm x 76mm)
- 038041 Medium, 7/8" x 4" (22mm x 102mm)
- 038042 Large, 1" x 4 $\frac{3}{4}$ " (25mm x 121mm)
- 038043 Extra Large, 1" x 6 1/2" (25mm x 165mm)
- 030917-LTZ Extra Long Snowman Clinton, 1" x 6" (25mm x 152mm)
- 038044 Medium, Right Side Open, 7/8" x 4" (22mm x 102mm)
- 038044-LT Medium, Left Side Open, 7/8" x 4" (22mm x 102mm)
- 038045 Large, Right Side Open, 1" x 4 3/4" (25mm x 121mm)
- 038045-LT Large, Left Side Open, 1" x 4 3/4" (25mm x 121mm)



Pederson Vu-More Speculum, (40mm) Open Channel

- 038100 Medium 4 $\frac{1}{2}$ " (114mm)
- 038101 Large 4 $\frac{7}{8}$ " (124mm)
- 038102 Extra Large 5 $\frac{7}{8}$ " (149mm)



Pederson Vu-Max Speculum, (70mm) Open Channel

- 038110 Medium 4 $\frac{1}{2}$ " (114mm)
- 038111 Large 4 $\frac{7}{8}$ " (124mm)
- 038112 Extra Large 5 $\frac{7}{8}$ " (149mm)



Weisman Open Side Speculum Closed Tube

- 038050 Right Side Open Medium $1\frac{3}{8}" \times 4"$ (35mm x 102mm)
- 038050-ANG Right Side Open Medium Angled $1\frac{3}{8}" \times 4"$ (35mm x 102mm)
- 038052 Right Side Open Large $1\frac{3}{8}" \times 4\frac{3}{4}"$ (35mm x 121mm)
- 038052-ANG Right Side Open Large Angled $1\frac{3}{8}" \times 4\frac{3}{4}"$ (35mm x 121mm)
- 038051 Left Side Open Medium $1\frac{3}{8}" \times 4"$ (35mm x 102mm)
- 038051-ANG Left Side Open Medium Angled $1\frac{3}{8}" \times 4"$ (35mm x 102mm)
- 038053 Left Side Open Large $1\frac{3}{8}" \times 4\frac{3}{4}"$ (35mm x 121mm)
- 038053-ANG Left Side Open Large Angled $1\frac{3}{8}" \times 4\frac{3}{4}"$ (35mm x 121mm)



Collins Speculum Closed Tube

- 038047 Small $1\frac{1}{4}" \times 3\frac{3}{4}"$ (32mm x 95mm)
- 038048 Medium $1\frac{3}{8}" \times 4"$ (35mm x 102mm)
- 038049 Large $1\frac{5}{8}" \times 4\frac{1}{2}"$ (41mm x 114mm)



Four-Way Lateral Speculum Open Channel

- 038093 Medium $\frac{7}{8}" \times 4\frac{1}{4}"$ (22mm x 108mm)
- 038094 Large $\frac{7}{8}" \times 5\frac{1}{4}"$ (22mm x 133mm)



Lateral Vaginal Wall Retractor

- 038060 Closed, 10" (254mm), Blade Size $1" \times 2\frac{1}{2}"$ (25mm x 64mm)
- 038061 Open $\frac{1}{2}"$ (13mm) 10" (254mm), Blade Size $1" \times 2\frac{1}{2}"$ (25mm x 64mm)
- 038062 Open 1" (25mm) 10" (254mm) Blade Size $1" \times 2\frac{1}{2}"$ (25mm x 64mm)
- 038063 Wide Open, 10" (254mm) Blade Size $1" \times 2\frac{1}{2}"$ (25mm x 64mm)



Klopfer Speculum Closed Tube

- 038054 $1\frac{3}{8}" \times 3\frac{1}{2}"$ (35mm x 89mm)



LLETZ Kogan Endocervical Speculum

038057 Speculum 2-4mm, 11" (279mm)

038058 Speculum 4-8mm, 11" (279mm)

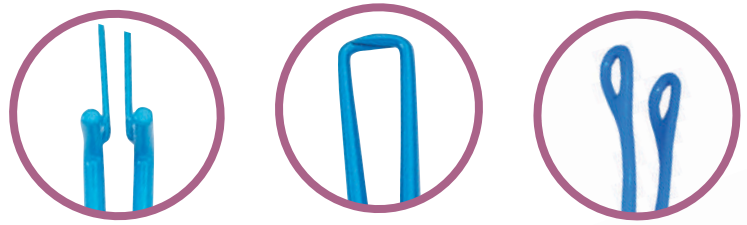

LLETZ Tenaculum

038070 Single-Tooth Tenaculum 9¾" (248mm)

LLETZ Foerster Forceps

038071 Lletz Foerster Forceps - Straight 9½" (241mm)

038072 Lletz Foerster Forceps - Curved 9½" (241mm)



LLETZ Tenaculum Hook

038080 Emmet Tenaculum 9" (229mm)

038081 Iris Tenaculum Hook 9" (229mm)

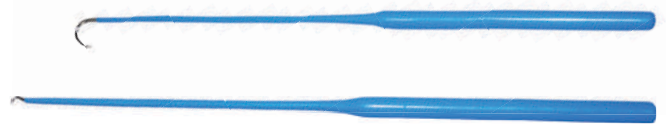

LLETZ Dressing Forceps

038082 Lletz Dressing Forceps Small 8" (203mm)

038092 Lletz Dressing Forceps Large 10" (254mm)



LLETZ Tissue Forceps

038090 Lletz Tissue Forceps Small 8" (203mm)

038091 Lletz Tissue Forceps Large 10" (254mm)

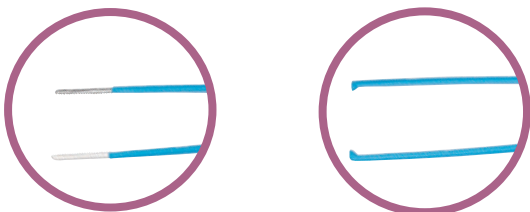

MedGyn Tenaculums

Schroeder Braun Single-Tooth Tenaculum

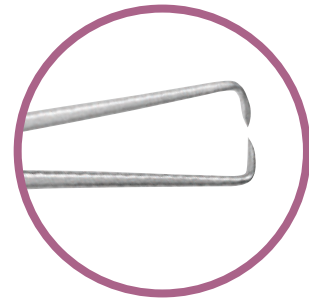

- 031004 Schroeder Braun Single-Tooth - 9³/₄" (248mm)
- 031019 Schroeder Braun Tenaculum Light-Touch Straight - 9³/₄" (248mm)
- 031034 Schroeder Braun Tenaculum Economy - 9³/₄" (248 mm)
- 031018 Braun Tenaculum Light-Touch Round - 7¹/₄" (184mm)

Skene Single-Tooth Tenaculum

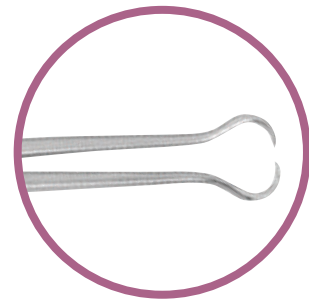

- 031006 Skene Single-Tooth-Side-Curve - 10" (254mm)

Duplay Single-Tooth Tenaculum

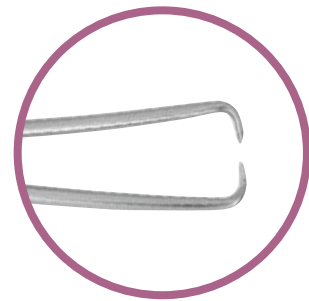

- 031008 Duplay Single-Tooth Double-Curve - 11" (279mm)

Barrett Tenaculum

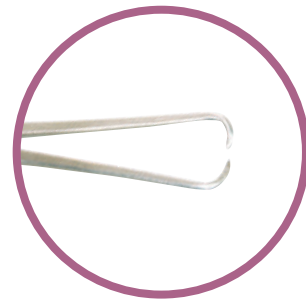

031009 Barrett Straight - 7¼" (184mm)

Jacobson Double-Tooth Tenaculum



031199 Jacobson Double-Tooth 10" Straight - 2x2
Teeth with Larger Rings (254mm)

031200 Jacobson Double-Tooth 10" Side Curve - 2x2
Teeth with Larger Rings (254mm)

Jacobs Double-Tooth Tenaculum



031197 Jacobs Double-Tooth 8½" Straight -
2x2 Teeth (215mm)

031198 Jacobs Double-Tooth 8½" Side Curve -
2x2 Teeth (215mm)

Schroeder Double-Tooth Tenaculum



- 031011 Schroeder Double-Tooth - 10" Straight (254mm)
- 031012 Schroeder Double-Tooth - 10" Curved (254mm)
- 031013 Schroeder Double-Tooth - 10" Side Curve (254mm)

Bierer Tenaculum



- 031010 Bierer Angled 5x6 Teeth, 9" (229mm)
- 031033 Bierer Angled 5x6 Teeth, Economy 9" (229mm)

Teale Tenaculum



- 031005 Teale Curved, 3x4 Teeth, 5mm Wide, 10" (254mm)

Kelly Tenaculum



- 031017 Kelly Tenaculum 4X5 Teeth, 9" (229mm)

Atraumatic Tenaculum

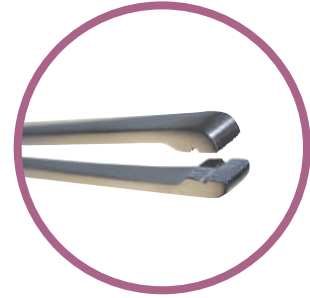

- 031001 Atraumatic Straight 1/4" (6mm) Jaws, 9" (229mm)
- 031002 Atraumatic Straight 1/8" (3mm) Jaws, 9" (229mm)
- 031003 Atraumatic Angled 1/4" (6mm) Jaws, 9 1/2" (241mm)

Shah Tenaculum



- 031016 Shah Tenaculum 9 1/2" (241mm)

Iris Hook



- 030406 Iris Hook 10" (254mm)

Emmett Tenaculum Hooks



- 031401 Emmett Curved Hook 9 1/2" (241mm)
- 031402 Emmett Half-Curved Hook 9 3/4" (248mm)
- 031403 Emmett Hook L-Shaped 9" (229mm)
- 031404 Emmett Hook Acute Angle 9" (229mm)
- 031405 Emmett Hook Double Angled 9" (229mm)

MedGyn Blue Titanium Biopsy Punch

Tischler Biopsy Punch

Classic Tischler bite with durable coating.
Bite Size: 7mm x 3mm

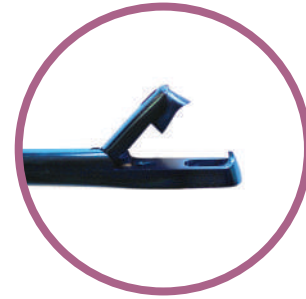

- 030176 Tischler Biopsy Punch Blue Titanium Heavy-Grip Handle 10" (254mm)
- 030181 Tischler Biopsy Punch Blue Titanium 10" (254mm)

- 030128 Tischler Biopsy Punch Blue Titanium 8½" (216mm)

Baby Tischler Biopsy Punch

Smaller bite size designed for less trauma with durable coating. Bite Size: 4.2mm x 2.3mm



- 030177 Baby Tischler Biopsy Punch Blue Titanium Heavy-Grip Handle 10" (254mm)
- 030129 Baby Tischler Biopsy Punch Blue Titanium 8½" (216mm)

- 030180 Baby Tischler Biopsy Punch Blue Titanium 10" (254mm)

Baby Tischler Biopsy Punch (Forceps Style)

Smaller bite size designed for less trauma with durable coating. Bite Size: 4.2mm x 2.3mm



- 030179 Baby Tischler Biopsy Punch Blue Titanium Gold Handle (Forceps Style) 10" (254mm)

Kevorkian Biopsy Punch

Popular design with strong, narrow jaw with durable coating and a heavy-grip handle. Bite Size: 8mm x 3mm

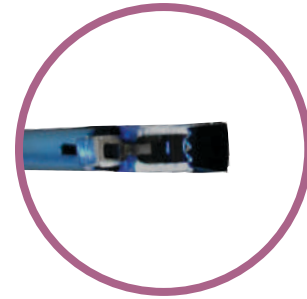

030178 Kevorkian Biopsy Punch Blue Titanium
Heavy-Grip Handle 10" (254mm)

Oval Tischler Biopsy Punch

Oval Tischler bite with durable coating and a heavy-grip handle.



030175 Oval Tischler Biopsy Punch Blue Titanium
Heavy-Grip Handle 10" (254mm)

MedGyn Gold Titanium Biopsy Punch

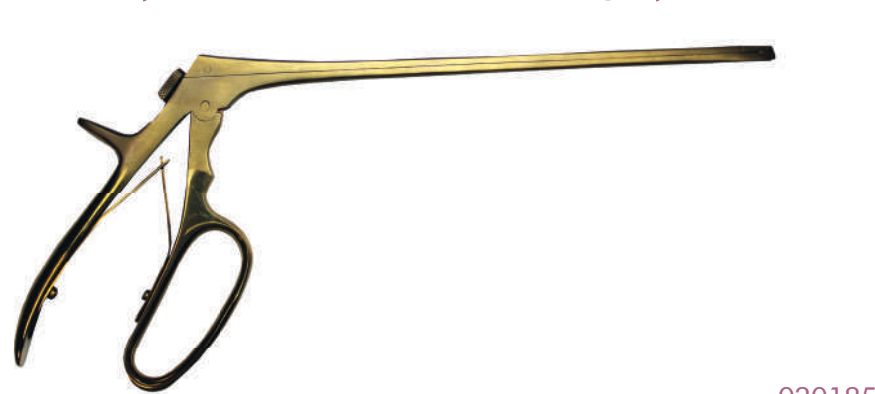

- 030182 Tischler Biopsy Punch Gold Titanium (250mm)
- 030183 Tischler Biopsy Punch, Gold Titanium (200mm)
- 030184 Baby Tischler Biopsy Punch Gold Titanium (250mm)

- 030185 Baby Tischler Biopsy Punch Gold Titanium (200mm)
- 030186 Kevorkian Biopsy Punch Gold Titanium (250mm)
- 030187 Kevorkian Biopsy Punch Gold Titanium (200mm)

MedGyn Titanium Biopsy Punch

Tischler Biopsy Punch

Classic Tischler bite, with durable coating.

Bite Size: 7mm x 3mm



- 030172 Tischler Biopsy Punch Titanium 10" (254mm) Heavy-Grip Handle
- 030120 Tischler Biopsy Punch Titanium 10" (254mm)
- 030124 Tischler Biopsy Punch Titanium 10" (254mm)-Angled Up
- 030125 Tischler Biopsy Punch Titanium 10" (254mm)-Angled Down
- 030162 Tischler Biopsy Punch Titanium 10" (254mm)-Angled Left
- 030163 Tischler Biopsy Punch Titanium 10" (254mm)-Angled Right
- 030118 Tischler Biopsy Punch Titanium 8½" (216mm)
- 030122 Tischler Biopsy Punch Titanium 8½" (216mm)-Angled Up
- 030123 Tischler Biopsy Punch Titanium 8½" (216mm)-Angled Down
- 030138 Tischler Biopsy Punch Titanium 8½" (216mm)-Angled Right
- 030139 Tischler Biopsy Punch Titanium 8½" (216mm)-Angled Left

Baby Tischler Biopsy Punch (Forceps Style)

Classic Baby Tischler bite with durable coating. Bite Size:

4.2mm x 2.3mm



- 030170 Baby Tischler Biopsy Punch Titanium Gold Handle (Forceps Style) 10" (254mm)

Oval Tischler Biopsy Punch

Bite Size: 7mm x 3mm



030171 Oval Tischler Biopsy Punch Titanium Heavy-Grip Handle 10" (254mm)

Kevorkian Biopsy Punch

Popular design with strong, narrow jaw with durable coating. Bite Size: 8mm x 3mm.



030174 Kevorkian Biopsy Punch Titanium Heavy-Grip Handle 10" (254mm)

030127 Kevorkian Biopsy Punch Titanium 10" (254mm)

030126 Kevorkian Biopsy Punch Titanium 8½" (216mm)

Baby Tischler Biopsy Punch

Smaller bite size designed for less trauma with durable coating. Bite Size: 4.2mm x 2.3mm



- 030173 Baby Tischler Biopsy Punch Titanium 10" (254mm) Heavy-Grip Handle
- 030121 Baby Tischler Biopsy Punch Titanium 10" (254mm)
- 030134 Baby Tischler Biopsy Punch Titanium 10" (254mm) - Angled Up
- 030135 Baby Tischler Biopsy Punch Titanium 10" (254mm) - Angled Down
- 030161 Baby Tischler Biopsy Punch Titanium 10" (254mm) - Angled Left
- 030160 Baby Tischler Biopsy Punch Titanium 10" (254mm) - Angled Right

- 030119 Baby Tischler Biopsy Punch Titanium 8½" (216mm)
- 030132 Baby Tischler Biopsy Punch Titanium 8½" (216mm) - Angled Up
- 030133 Baby Tischler Biopsy Punch Titanium 8½" (216mm) - Angled Down
- 030159 Baby Tischler Biopsy Punch Titanium 8½" (216mm) - Left
- 030158 Baby Tischler Biopsy Punch Titanium 8½" (216mm) - Right

MedGyn Stainless Steel Biopsy Punch

Tischler Biopsy Punch

Classic Tischler bite designed for drawing in maximum tissue near os with minimal trauma.

Bite Size 7mm x 3mm



- | | |
|---|---|
| 030101-10 Tischler Biopsy Punch 10" (254mm) | 030101 Tischler Biopsy Punch 8½" (216mm) |
| 029801 Tischler Biopsy Punch 10" (254mm) Angled Up | 030113 Tischler Biopsy Punch 8½" (216mm) Angled Up |
| 029802 Tischler Biopsy Punch 10" (254mm) Angled Down | 030114 Tischler Biopsy Punch 8½" (216mm) Angled Down |
| 029803 Tischler Biopsy Punch 10" (254mm) Angled Left | 030136 Tischler Biopsy Punch 8½" (216mm) Angled Left |
| 029804 Tischler Biopsy Punch 10" (254mm) Angled Right | 030137 Tischler Biopsy Punch 8½" (216mm) Angled Right |

Baby Tischler Biopsy Punch

Smaller bite size designed for less trauma.

Bite Size: 4.2mm x 2.3mm



- 030102-10 Baby Tischler Biopsy Punch 10" (254mm)
- 029811 Baby Tischler Biopsy Punch 10" (254mm) Angled Up
- 029812 Baby Tischler Biopsy Punch 10" (254mm) Angled Down
- 029813 Baby Tischler Biopsy Punch 10" (254mm) Angled Left
- 029814 Baby Tischler Biopsy Punch 10" (254mm) Angled Right
- 030102 Baby Tischler Biopsy Punch 8½" (216mm)
- 030140 Baby Tischler Biopsy Punch 8½" (216mm) Angled Up
- 030141 Baby Tischler Biopsy Punch 8½" (216mm) Angled Down
- 030142 Baby Tischler Biopsy Punch 8½" (216mm) Angled Left
- 030143 Baby Tischler Biopsy Punch 8½" (216mm) Angled Right

Kevorkian Biopsy Punch

(Kevorkian-Younger Biopsy Forceps displayed)

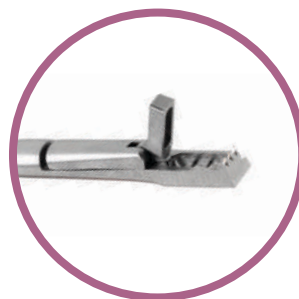

- 030103-10 Kevorkian Biopsy Punch 10" (254mm)
- 030103 Kevorkian Biopsy Punch 8½" (216mm)
- 030169 Kevorkian-Younger Biopsy Forceps without Spring 8" (203mm)

Tischler-Kevorkian Cervical Biopsy Punch



- 030116 Tischler-Kevorkian Biopsy Punch 10" (254mm)
- 030115 Tischler-Kevorkian Biopsy Punch 8½" (216mm)

Burke Biopsy Punch

Open-handle design for optimal control with small cutting jaws and sharp teeth.

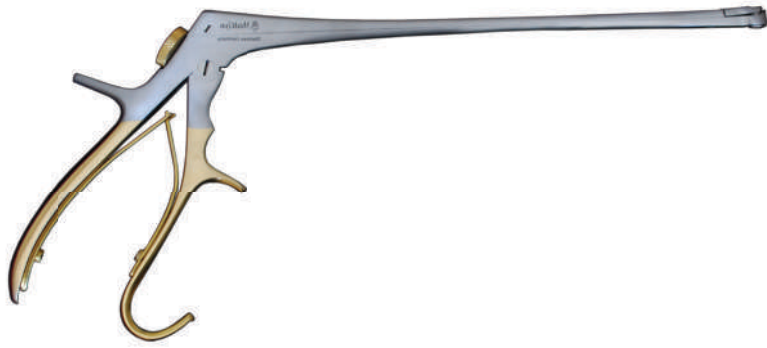

030109 Burke Biopsy Punch 8½" (216mm)

Eppendorfer Biopsy Forceps



030110 Eppendorfer Biopsy Forceps 8" (203mm)

Van Doren Biopsy Forceps



030155 Van Doren Biopsy Forceps with Ratchet 10" (254mm)

030166 Van Doren Biopsy Forceps without Ratchet 10" (254mm)

Schubert Biopsy Forceps



030157 Schubert Biopsy Forceps 10" (254mm) Curved

Wittner Biopsy Punch



030117 Wittner Biopsy Punch 8½" (216mm)

Rotating Biopsy Punch Options



- 030778 Vulvar Keyes Biopsy Punch Set (Handle + 6 Tips)
- 030104 Rotating Tischler Biopsy Punch
- 030145 Rotating Tischler Biopsy Punch - Angled Down
- 030146 Rotating Tischler Biopsy Punch - Angled Up
- 030105 Rotating Baby Tischler Biopsy Punch
- 030105-DOWN Rotating Baby Tischler Biopsy Punch - Angled Down
- 030105-UP Rotating Baby Tischler Biopsy Punch - Angled Up
- 030106 Rotating Kevorkian Biopsy Punch
- 030107 Rotating Burke Biopsy Punch
- 030111-BB Rotating Shaft - Baby Tischler Tip Only
- 030111-BRK Rotating Shaft - Burke Tip Only
- 030111-KEV Rotating Shaft - Kevorkian Tip Only
- 030111-TIS Rotating Shaft - Tischler Tip Only
- 030147 Rotating Shaft - Tischler Tip - Up
- 030148 Rotating Shaft - Tischler Tip - Down
- 030108 Rotating Biopsy Punch Handle Only
- 030100 Rotating Shaft (with any tip)

MedGyn Double-End Dilators

Pratt Dilator

Stainless steel double-end dilator 11½" (292mm)



- 030850 Pratt 8 Piece Dilator Set 13-15 Fr - 41-43 Fr
- 030850-ECO Pratt 8 Piece Dilator Set 13-15 Fr -41-43 Fr
- 030859 Pratt Dilator 9-11Fr
- 030851 Pratt Dilator 13-15 Fr
- 030852 Pratt Dilator 17-19 Fr
- 030853 Pratt Dilator 21-23 Fr
- 030854 Pratt Dilator 25-27 Fr
- 030855 Pratt Dilator 29-31 Fr
- 030856 Pratt Dilator 33-35 Fr
- 030857 Pratt Dilator 37-39 Fr
- 030858 Pratt Dilator 41-43 Fr

Hank Dilator

Designed with guide rings for ease-of-use 11" (279mm)



- 030801 Hank 6 Piece Dilator Set 11-12 Fr - 21-22 Fr
- 030801-7 Hank 7 Piece Dilator Set 9-10 Fr - 21-22 Fr
- 030801-7/8 Hank Dilator 7-8 Fr
- 030801-9/10 Hank Dilator 9-10 Fr
- 030801-11/12 Hank Dilator 11-12 Fr
- 030801-13/14 Hank Dilator 13-14 Fr
- 030801-15/16 Hank Dilator 15-16 Fr
- 030801-17/18 Hank Dilator 17-18 Fr
- 030801-19/20 Hank Dilator 19-20 Fr
- 030801-21/22 Hank Dilator 21-22 Fr

Pratt Extra Large Dilator

Pratt style in larger sizes 11½" (292mm).



- 030870 Pratt Extra Large 9 Piece Dilator Set 45-47 Fr - 77-79 Fr
- 030870-ECO Pratt Extra Large 9 Piece Dilator Set 45-47 Fr - 77-79 Fr
- 030871 Pratt Dilator Extra Large 45-47 Fr
- 030872 Pratt Dilator Extra Large 49-51 Fr
- 030873 Pratt Dilator Extra Large 53-55 Fr
- 030874 Pratt Dilator Extra Large 57-59 Fr
- 030875 Pratt Dilator Extra Large 61-63 Fr
- 030876 Pratt Dilator Extra Large 65-67 Fr
- 030877 Pratt Dilator Extra Large 69-71 Fr
- 030878 Pratt Dilator Extra Large 73-75 Fr
- 030879 Pratt Dilator Extra Large 77-79 Fr
- 030880 Pratt Extra Large, Light Weight 9 Piece Dilator Set 45-47 Fr - 77-79 Fr
- 030881 Pratt Extra Large, Light Weight 45-47 Fr
- 030882 Pratt Extra Large, Light Weight 49-51 Fr
- 030883 Pratt Extra Large, Light Weight 53-55 Fr
- 030884 Pratt Extra Large, Light Weight 57-59 Fr
- 030885 Pratt Extra Large, Light Weight 61-63 Fr
- 030886 Pratt Extra Large, Light Weight 65-67 Fr
- 030887 Pratt Extra Large, Light Weight 69-71 Fr
- 030888 Pratt Extra Large, Light Weight 73-75 Fr
- 030889 Pratt Extra Large, Light Weight 77-79 Fr

Hegar Dilator

Stainless steel double-end dilator 7½" (191mm).



- 030830 Hegar 8 Piece Dilator Set 3-4mm - 17-18mm
- 030831 Hegar Dilator 1-2mm
- 030832 Hegar Dilator 3-4mm
- 030833 Hegar Dilator 5-6mm
- 030834 Hegar Dilator 7-8mm
- 030835 Hegar Dilator 9-10mm
- 030836 Hegar Dilator 11-12mm
- 030837 Hegar Dilator 13-14mm
- 030838 Hegar Dilator 15-16mm
- 030839 Hegar Dilator 17-18mm

Kleegman Dilator

Double-end dilator available in stainless steel and Teflon™. (Stainless steel pictured) (1.0mm/2.0mm)



- 030804 Kleegman Stainless Steel Dilator 11" (279mm)
- 030805 Kleegman Teflon™ Dilator 12" (305mm)

MedGyn Single-End Dilators

Hern Dilator

Teflon single-end dilator with handle 14¾" (375mm)



- 030807 Hern 21 Piece Dilator Set Sizes 44 Fr - 104 Fr
- 030808 Hern Dilator 44 Fr
- 030809 Hern Dilator 47 Fr
- 030810 Hern Dilator 50 Fr
- 030811 Hern Dilator 53 Fr
- 030812 Hern Dilator 56 Fr
- 030813 Hern Dilator 59 Fr
- 030814 Hern Dilator 62 Fr
- 030815 Hern Dilator 65 Fr
- 030816 Hern Dilator 68 Fr
- 030817 Hern Dilator 71 Fr
- 030818 Hern Dilator 74 Fr
- 030819 Hern Dilator 77 Fr
- 030820 Hern Dilator 80 Fr
- 030821 Hern Dilator 83 Fr
- 030822 Hern Dilator 86 Fr
- 030823 Hern Dilator 89 Fr
- 030824 Hern Dilator 92 Fr
- 030825 Hern Dilator 95 Fr
- 030826 Hern Dilator 98 Fr
- 030827 Hern Dilator 101 Fr
- 030828 Hern Dilator 104 Fr
- 030829-107 Hern Dilator 107 Fr
- 030829-110 Hern Dilator 110 Fr
- 030829-113 Hern Dilator 113 Fr

Hawkin Ambler

Stainless steel single-end, dilator 7¼" (184mm)



- | | | | |
|--------|--|--------|-------------------------------|
| 030780 | 16 Piece Dilator Set Sizes 3-6mm - 18-21mm | 030789 | Hawkin Ambler Dilator 11-14mm |
| 030781 | Hawkin Ambler Dilator 3-6mm | 030790 | Hawkin Ambler Dilator 12-15mm |
| 030782 | Hawkin Ambler Dilator 4-7mm | 030791 | Hawkin Ambler Dilator 13-16mm |
| 030783 | Hawkin Ambler Dilator 5-8mm | 030792 | Hawkin Ambler Dilator 14-17mm |
| 030784 | Hawkin Ambler Dilator 6-9mm | 030793 | Hawkin Ambler Dilator 15-18mm |
| 030785 | Hawkin Ambler Dilator 7-10mm | 030794 | Hawkin Ambler Dilator 16-19mm |
| 030786 | Hawkin Ambler Dilator 8-11mm | 030795 | Hawkin Ambler Dilator 17-20mm |
| 030787 | Hawkin Ambler Dilator 9-12mm | 030796 | Hawkin Ambler Dilator 18-21mm |
| 030788 | Hawkin Ambler Dilator 10-13mm | | |

Hegar Dilator

Stainless steel single-end dilator 7½" (191mm)



- | | | | |
|------------|---------------------|-------------|----------------------|
| 030841-1 | Hegar Dilator 1mm | 030842-10 | Hegar Dilator 10mm |
| 030841-1.5 | Hegar Dilator 1.5mm | 030842-10.5 | Hegar Dilator 10.5mm |
| 030841-2 | Hegar Dilator 2mm | 030843-11 | Hegar Dilator 11mm |
| 030841-2.5 | Hegar Dilator 2.5mm | 030843-11.5 | Hegar Dilator 11.5mm |
| 030841-3 | Hegar Dilator 3mm | 030843-12 | Hegar Dilator 12mm |
| 030841-3.5 | Hegar Dilator 3.5mm | 030843-12.5 | Hegar Dilator 12.5mm |
| 030841-4 | Hegar Dilator 4mm | 030843-13 | Hegar Dilator 13mm |
| 030841-4.5 | Hegar Dilator 4.5mm | 030843-13.5 | Hegar Dilator 13.5mm |
| 030841-5 | Hegar Dilator 5mm | 030843-14 | Hegar Dilator 14mm |
| 030841-5.5 | Hegar Dilator 5.5mm | 030843-14.5 | Hegar Dilator 14.5mm |
| 030842-6 | Hegar Dilator 6mm | 030843-15 | Hegar Dilator 15mm |
| 030842-6.5 | Hegar Dilator 6.5mm | 030843-15.5 | Hegar Dilator 15.5mm |
| 030842-7 | Hegar Dilator 7mm | 030844-16 | Hegar Dilator 16mm |
| 030842-7.5 | Hegar Dilator 7.5mm | 030844-16.5 | Hegar Dilator 16.5mm |
| 030842-8 | Hegar Dilator 8mm | 030844-17 | Hegar Dilator 17mm |
| 030842-8.5 | Hegar Dilator 8.5mm | 030844-17.5 | Hegar Dilator 17.5mm |
| 030842-9 | Hegar Dilator 9mm | 030844-18 | Hegar Dilator 18mm |
| 030842-9.5 | Hegar Dilator 9.5mm | 030844-18.5 | Hegar Dilator 18.5mm |

Os Cervical Finder Set

Made of soft, malleable reusable material.

3 piece set (Os Finder, Canal Finder & Fundus Finder)



- | | |
|--------|---|
| 030803 | Os Cervical Finder 3 Piece Set - Reusable |
|--------|---|

Pratt Dilator Plastic

Light-weight, reusable 5 piece plastic dilator set.

030890 Pratt Dilator Plastic 5 Piece Set 5-6mm-
13-14mm

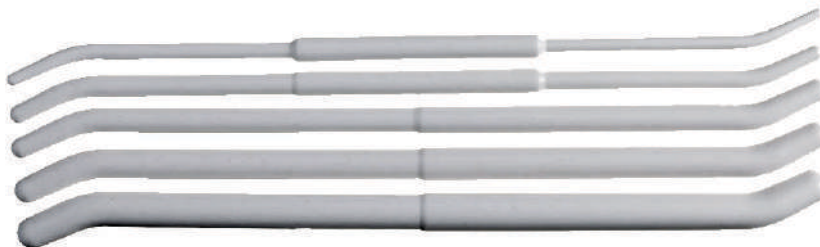

Mini Dilator Set

6 piece set (5 dilators & handle).



030779 6 Piece Mini Dilator Set:
1mm, 1.5mm, 2mm, 2.5mm, 3mm



030779BT Mini Dilator Set Blue Titanium

McMahan Cervico Meter

Angled, used for measuring dilation of cervix.

031300 McMahan Cervico Meter



MedGyn Endometrial Curettes

Sims Curette

Metal curette with sharp blade on malleable or rigid shanks 11" (279mm)



- | | | | |
|--------|---|--------|---|
| 030640 | Sims Malleable Curette 8 Piece Set Sizes #00 - #6 | 030639 | Sims Malleable Curette #10 |
| 030640 | 12 Sims Malleable Curette 12 Piece Set Sizes #00-10 | 030650 | Sims Rigid Curette 8 Piece Set Sizes #00 - #6 |
| 030641 | Sims Malleable Curette #00 | 030651 | Sims Rigid Curette #00 |
| 030642 | Sims Malleable Curette #0 | 030652 | Sims Rigid Curette #0 |
| 030643 | Sims Malleable Curette #1 | 030653 | Sims Rigid Curette #1 |
| 030644 | Sims Malleable Curette #2 | 030654 | Sims Rigid Curette #2 |
| 030645 | Sims Malleable Curette #3 | 030655 | Sims Rigid Curette #3 |
| 030646 | Sims Malleable Curette #4 | 030656 | Sims Rigid Curette #4 |
| 030647 | Sims Malleable Curette #5 | 030657 | Sims Rigid Curette #5 |
| 030648 | Sims Malleable Curette #6 | 030658 | Sims Rigid Curette #6 |
| 030649 | Sims Malleable Curette #7 | 030659 | Sims Rigid Curette #7 |
| 030637 | Sims Malleable Curette #8 | 030660 | Sims Rigid Curette #8 |
| 030638 | Sims Malleable Curette #9 | 030661 | Sims Rigid Curette #9 |
| | | 030662 | Sims Rigid Curette #10 |

Bumm Curette

Extra-large metal curettes on malleable shanks



- | | |
|--------|---|
| 030620 | 4 Piece Set - Sizes #1 - #4 12" (305mm) |
| 030621 | Bumm - Size #1 12" (305mm) |
| 030622 | Bumm - Size #2 12" (305mm) |
| 030623 | Bumm - Size #3 12" (305mm) |
| 030624 | Bumm - Size #4 12" (305mm) |

Banjo/Hunter Curette



- | | |
|--------|--|
| 030619 | Banjo/Hunter Curette Size 14 - 30mm 13½" (343mm) |
|--------|--|

Evans Curette



- 030630 Evans Curette 6 Piece Set Sizes #0 - #5
11" (279mm)
- 030631 Evans Curette #0-4mm 11" (279mm)
- 030632 Evans Curette #1-6mm 11" (279mm)
- 030633 Evans Curette #2-8mm 11" (279mm)
- 030634 Evans Curette #3-10mm 11" (279mm)
- 030635 Evans Curette #4-12mm 11" (279mm)
- 030636 Evans Curette #5-14mm 11" (279mm)

Novak Curette

Popular metal curette available in a 3 piece set or in individual sizes.

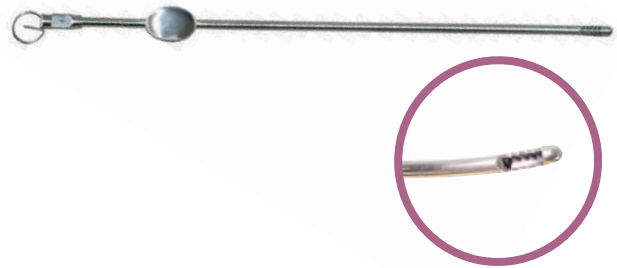

- 030600 Novak Curette 3 Piece Set 2mm - 4mm 9³/₄"
(248mm)
- 030602 Novak Curette 2mm 9³/₄" (248mm)
- 030603 Novak Curette 3mm 9³/₄" (248mm)
- 030604 Novak Curette 4mm 9³/₄" (248mm)

Randall Curette

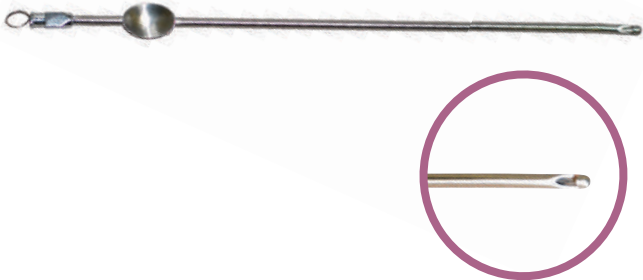

- 030610 Randall Curette 3 Piece Set #2 - #4 9³/₄" (248mm)
- 030612 Randall Curette #1 9³/₄" (248mm)
- 030613 Randall Curette #2 9³/₄" (248mm)
- 030614 Randall Curette #3 9³/₄" (248mm)

Heaney Curette



- 030680 Heaney Curette Small 9¹/₂" (241mm)

MedGyn Endocervical Curettes

Kevorkian-Younger Curette

Metal curette available with or without basket.

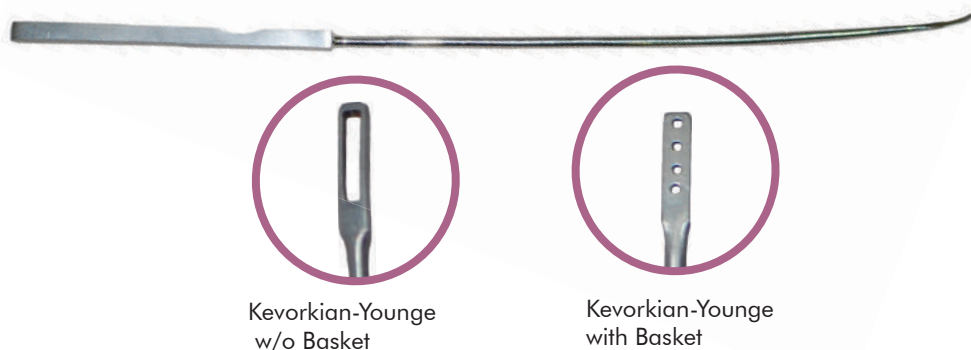

Kevorkian-Younger
w/o Basket

Kevorkian-Younger
with Basket

- 030301 Kevorkian-Younger Malleable Curette w/o Basket 12" (305mm)
- 030302 Kevorkian-Younger Malleable Curette with Basket 12" (305mm)
- 030303 Kevorkian-Younger Rigid Curette w/o Basket 12" (305mm)
- 030304 Kevorkian-Younger Rigid Curette with Basket 12" (305mm)
- 030303-H Kevorkian-Younger Rigid Curette w/o Basket (Square Tip, Gold Handle, Heavy) 12" (305mm)
- 030304-H Kevorkian-Younger Rigid Curette with Basket (Square Tip, Gold Handle, Heavy) 12" (305mm)
- 030315 Kevorkian-Younger Rigid Curette w/o Basket (Square Tip, Titanium) 12" (305mm)
- 030311 Kevorkian-Younger Rigid Curette with Basket (Square Tip, Titanium) 12" (305mm)
- 030306 Kevorkian-Younger Rigid Curette with Basket (Round Tip, Gold Handle, Heavy) 12" (305mm)
- 030310 Kevorkian-Younger Rigid Curette with Basket (Round Tip, Titanium) 12" (305mm)

Townsend Curette

Round, tapered tip allows for entry through stenotic os.



- 030305 Townsend Curette 12" (305mm)

Metal Uterine Sounds

MedGyn reusable, graduated metal sounds made of highly malleable metal.



- 030704 Simpson Uterine Sound 3mm Diameter, Graduated in inches, 13" (330mm)
- 030705 Simpson Uterine Sound 3mm Diameter, Graduated in cm, 13" (330mm)

Sims Uterine Sound



- 030700 Sims Uterine Sound 3mm Diameter, Graduated in inches, 13" (330mm)
- 030701 Sims Uterine Sound 3mm Diameter, Graduated in cm, 13" (330mm)
- 030702 Sims Uterine Sound 2mm Diameter, Graduated in cm, 13" (330mm)
- 030703 Sims Uterine Sound 3mm Plain Probe, Malleable, 13" (330mm)

MedGyn Ovum Forceps

Sopher Ovum Forceps

Slightly curved forceps with oval, serrated jaws.

- 031123 Sopher Ovum Forceps 11" (279mm) 12mm Jaws
- 031123R Sopher Ovum Forceps 11" (279mm) 12mm Jaws with Ratchet
- 031126 Sopher Ovum Forceps 11" (279mm) 14mm Jaws
- 031149 Sopher Ovum Forceps 11" (279mm) 14mm Jaws with Ratchet
- 031124 Sopher Ovum Forceps 13" (330mm) 12mm Jaws
- 031125 Sopher Ovum Forceps 13" (330mm) 12mm Jaws with Ratchet
- 031127 Sopher Ovum Forceps 13" (330mm) 14mm Jaws
- 031128 Sopher Ovum Forceps 13" (330mm) 14mm Jaws with Ratchet

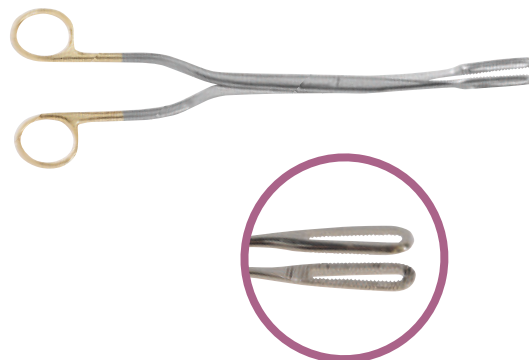

Bierer Ovum Forceps

Slightly curved forceps with oval, coarse, serrated jaws.

- 031131 Bierer Ovum Forceps 11"(279mm) 16mm Jaws
- 031132 Bierer Ovum Forceps 11"(279mm) 16mm Jaws with Ratchet
- 031135 Bierer Ovum Forceps 11" (279mm) 19mm Jaws
- 031136 Bierer Ovum Forceps 11" (279mm) 19mm Jaws with Ratchet
- 031133 Bierer Ovum Forceps 13" (330mm) 16mm Jaws
- 031134 Bierer Ovum Forceps 13" (330mm) 16mm Jaws with Ratchet
- 031137 Bierer Ovum Forceps 13" (330mm) 19mm Jaws
- 031138 Bierer Ovum Forceps 13" (330mm) 19mm Jaws with Ratchet

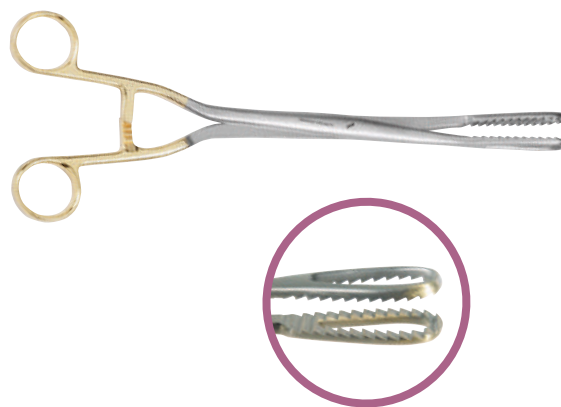

Sopher Original Forceps

Slightly curved forceps with oval jaw. Concave tip design to prevent grasping of fundus.

- 031129 Sopher Original Forceps 10½" (267mm) Small Jaws
- 031130 Sopher Original Forceps 10½" (267mm) Medium Jaws

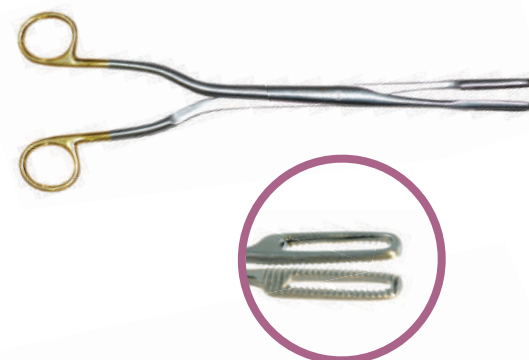

Hern Evacuation Forceps

Slightly curved forceps with coarse teeth, oval jaws.

- 031146 Hern Evacuation Forceps 13" (330mm) Small 12mm Jaws
- 031147 Hern Evacuation Forceps 13" (330mm) Medium 15mm Jaws
- 031148 Hern Evacuation Forceps 13" (330mm) Large 19mm Jaws

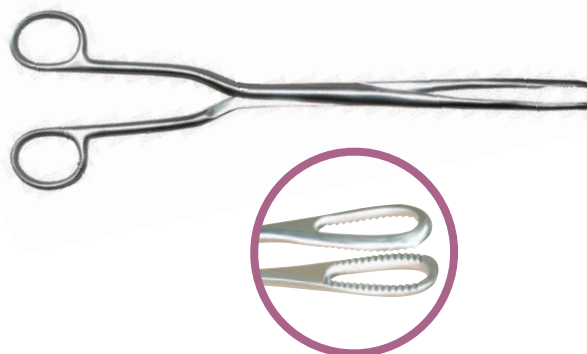

Hern-Patterson Forceps

Straight forceps with coarse teeth, oval jaws and ratchet.

031139 Hern Patterson Evacuation Forceps 13" (330mm) 17mm Jaws

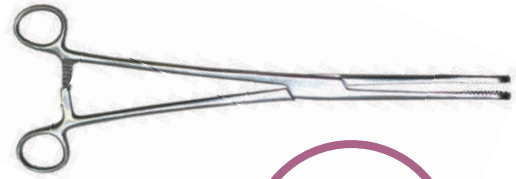

Hern Van-Lyth Forceps

Curved forceps with fine teeth.

031166 Hern Van Lyth Evacuation Forceps 9½" (241mm) 9mm Jaws

031167 Hern Van Lyth Evacuation Forceps 10" (254mm) 11mm Jaws



Agadi-Bierer Forceps

031153 Agadi-Bierer Forceps 13" (330mm) - 14mm without Ratchet

031154 Agadi-Bierer Forceps 13" (330mm) - 14mm with Ratchet



Ramplly Ring Forceps

031007 Ramplly with Oval Jaws 10" (254mm) Straight 13mm Jaws

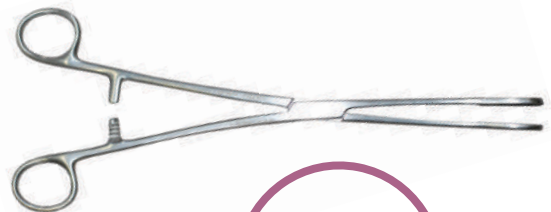

West-Gluck Forceps

031168 West-Gluck Forceps 11" (279mm) 13mm Jaws



Stubblefield Forceps

Slightly curved, very long forceps with oval jaws.

031144 Stubblefield Forceps 15" (381mm) 14mm Jaws

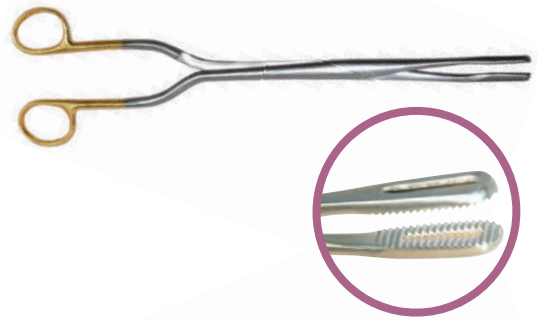

Agadi Evacuation Forceps

Smaller forceps available in both straight and curved versions with oval jaws.

031170 Agadi Evacuation Forceps 9¾" (248mm) Curved 8mm Jaws

031171 Agadi Evacuation Forceps 9½" (241mm) Straight 9mm Jaws

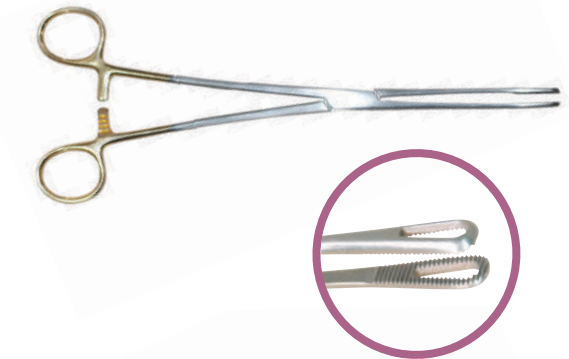

Blumenthal Forceps

Slightly curved forceps with large oval jaws and coarse teeth.

031141 Blumenthal Evacuation Forceps 13" (330mm) 20mm Jaws

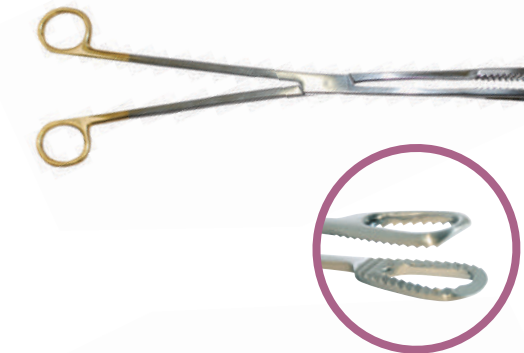

Saenger Forceps

Forceps with unique inner-diameter teeth within oval jaws.

031163 Saenger Ovum Forceps 11¼" (286mm) Curved 17mm Jaws

031164 Saenger Ovum Forceps 10¾" (273mm) Straight with Ratchet 17mm Jaws

031165 Saenger Ovum Forceps 10½" (267mm) Curved with Ratchet 17mm Jaws

031172 Saenger Ovum Forceps 13" (330mm) Straight with Ratchet 18mm Jaws

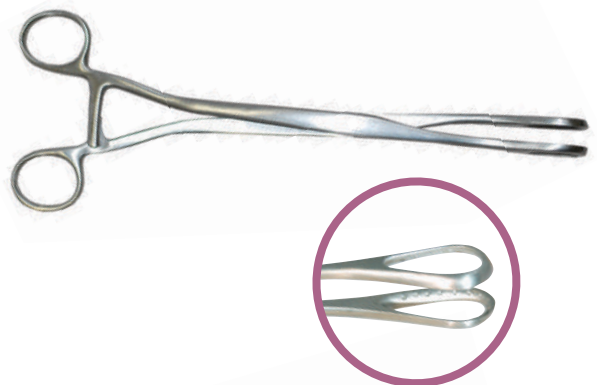

Jacobson Forceps

Slightly curved forceps, with coarse teeth, oval jaw and enlarged ring handles. With concave tip.

031142 Jacobson Evacuation Forceps 13" (330mm) Large with 20mm Jaws



Boston Forceps

Straight forceps with large oval jaws and coarse teeth.

- 031156 Boston Evacuation Forceps 13½" (343mm)
27mm Jaws - High Fulcrum
- 031157 Boston Evacuation Forceps 13½" (343mm)
27mm Jaws - Low Fulcrum

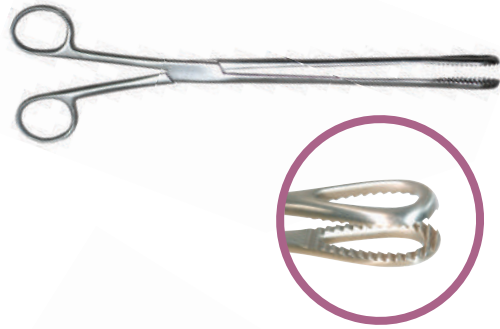

Meltzer Forceps

Meltzer Evacuation Forceps 13" (330mm)
19mm Jaws

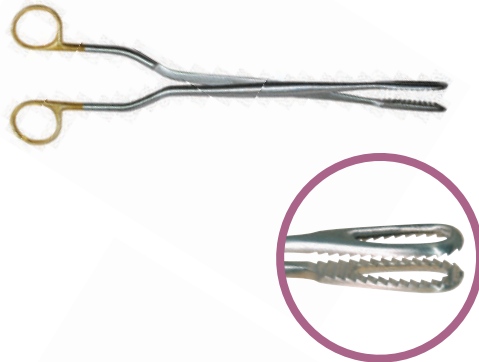

McClintock Forceps

Slightly curved with fine-tooth jaws.

031122 McClintock Ovum Forceps 9½"
(241mm) 14mm Jaws

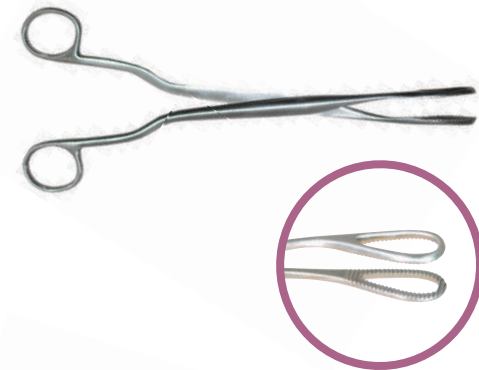

Fink Forceps

Slightly curved with jaws and concave tip.

031176 Fink Ovum Forceps 10½" (267mm)
13mm Jaws

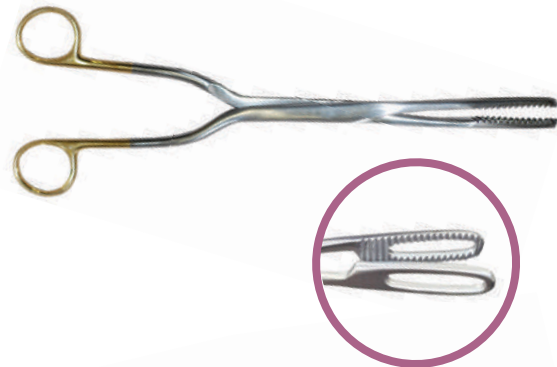

Lisa Forceps

031173 Lisa Forceps 10" (254mm)

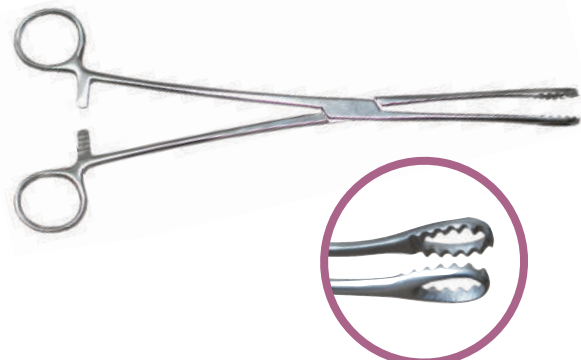

MedGyn Placenta Forceps

Hern-Barret Placenta Forceps

Slightly curved placenta forceps with oval jaws.

- 031151 Hern-Barret Placenta Forceps 13" (330mm)
16mm Serrated Jaws
- 031152 Hern-Barret Placenta Forceps 13" (330mm)
16mm Smooth Jaws

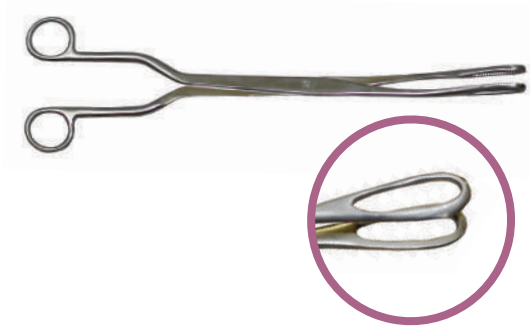

Kelly Placenta Forceps

Slightly curved placenta forceps with serrated jaws.

- 031140 Kelly Placenta Forceps 12.5" (318mm)
19mm Serrated Jaws

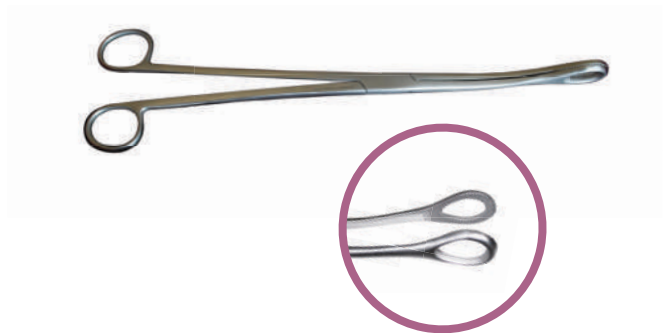

Hern-Kelly Placenta Forceps

Slightly curved placenta forceps with serrated jaws.

- 031145 Hern-Kelly 13" (330mm)
19mm Serrated Jaws



MedGyn Myoma Grasping Forceps

Myoma Grasping Forceps

Ideal for transcervical management of polyps and pedunculated myoma.

- 031210 Myoma Grasping Forceps 13" (330mm) 7mm Jaws
- 031211 Myoma Grasping Forceps 13" (330mm) 11mm Jaws
- 031212 Myoma Grasping Forceps 13" (330mm) 17mm Jaws

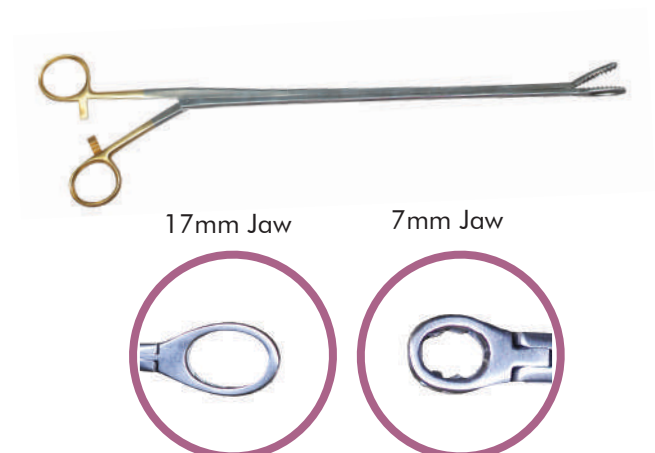

MedGyn Tissue Forceps

Ochsner Tissue Forceps

031169 Ochsner Tissue Forceps

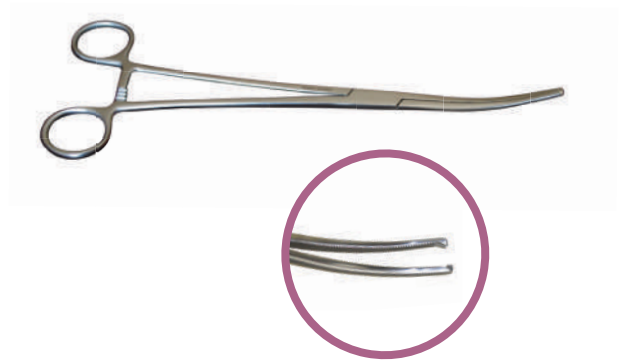

Baby Allis Tissue Forceps

031111 Baby Allis Forceps 5½" (140mm)

4x5 Teeth-Extra Delicate Jaws

031112 Baby Allis Forceps 5" (127mm)

4x5 Teeth-Extra Delicate Jaws



Adson Tissue Forceps

031196 Adson Tissue Forceps 4¾" (121mm)

1x2 Teeth



Tissue Forceps

031180 Tissue Forceps 8" (203mm) Small 1x2 Teeth

031181 Tissue Forceps 10" (254mm) Large 1x2 Teeth



Allis Tissue Forceps

031107 Allis Tissue Forceps 4" (104mm) 4x5 Teeth

031105 Allis Tissue Forceps 5" (127mm) 4x5 Teeth

031108 Allis Tissue Forceps 6" (152mm) 4x5 Teeth

031109 Allis Tissue Forceps 6" (152mm) 5x6 Teeth

031110 Allis Tissue Forceps 7½" (190mm) 5x6 Teeth

031103 Allis Tissue Forceps 9½" (241mm) 5x6 Teeth

031106 Allis Tissue Forceps 10" (254mm) 5x6 Teeth

031104 Allis Tissue Forceps 6" (152mm) 4x5 Teeth with Angular Jaws

031101 Allis Tissue Forceps 6" (152mm) 5x6 Teeth with Angular Jaws

031102 Allis Tissue Forceps 7¼" (184mm) 5x6 Teeth with Angular Jaws

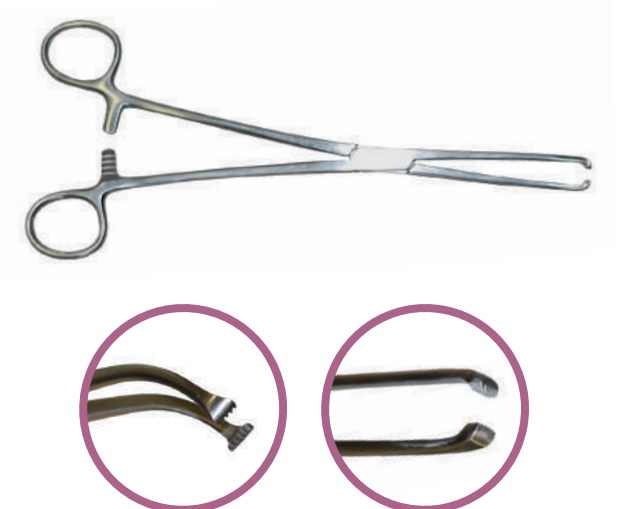

MedGyn Polyp Forceps

Polyp Forceps

031121 Polyp Forceps 10" (254mm) Narrow Jaws

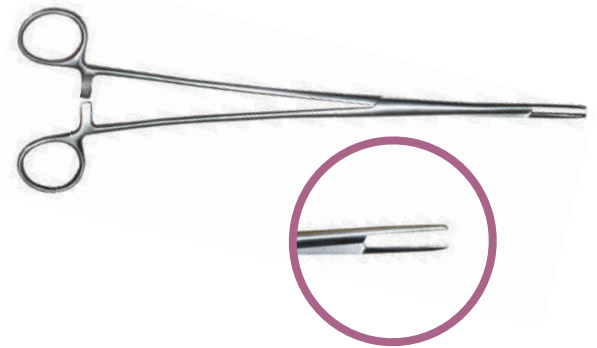

Alligator Forceps

Perfect design for retrieval of IUDs, with hinged serrated jaws.

030112 Alligator Forceps 8" (203mm)

030112-11 Alligator Forceps 11" (279mm)

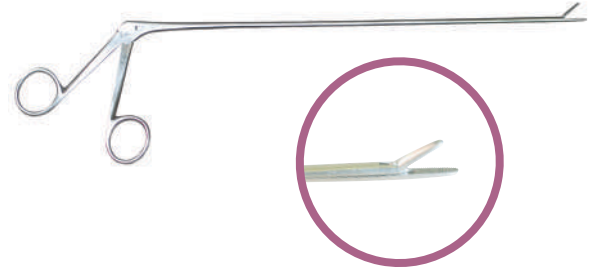

Foerster Dressing Forceps

031035 Foerster Dressing Forceps 9½" (241mm) Straight - Serrated Jaws

031037 Foerster Dressing Forceps 9½" (241mm) Straight - Smooth Jaws

031036 Foerster Dressing Forceps 9½" (241mm) Curved - Serrated Jaws

031038 Foerster Dressing Forceps 9½" (241mm) Curved - Smooth Jaws

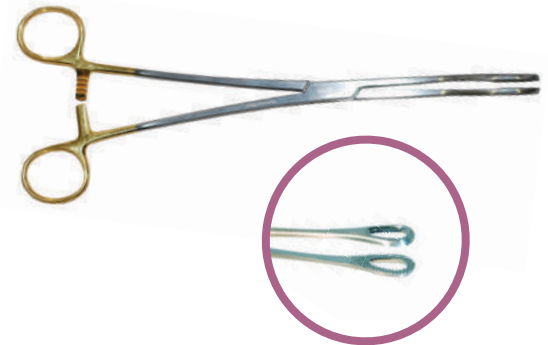

Halsted Mosquito Forceps

031113 Halsted Mosquito Hemostatic Forceps Straight 5" (127mm)

031114 Halsted Mosquito Hemostatic Forceps Straight with Delicate Teeth 5" (127mm)

031115 Halsted Mosquito Hemostatic Forceps Straight with 1x2 Teeth 5" (127mm)

031116 Halsted Mosquito Hemostatic Forceps Curved 5" (127mm)

031118 Halsted Mosquito Hemostatic Forceps Curved with Delicate Teeth 5" (127mm)

031119 Halsted Mosquito Hemostatic Forceps Curved with 1x2 Teeth 5" (127mm)

031116-ECO Halsted Mosquito Hemostatic Forceps Economy 5" (127mm)



Bozeman Uterine Dressing Forceps

- 031161 Bozeman Uterine Dressing 10½" (267mm) Straight
- 031162 Bozeman Uterine Dressing 10½" (267mm) Curved
- 031162-ECO Bozeman Uterine Dressing 10½" (267mm) Curved - Economy

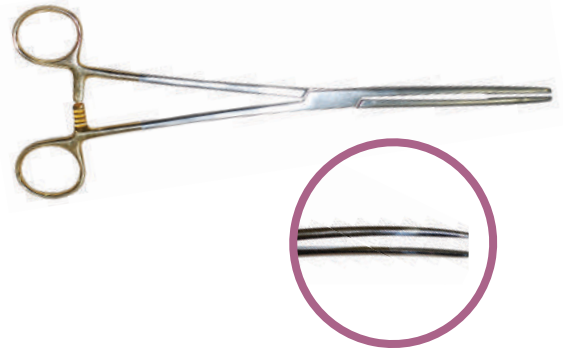

Dressing Forceps

- 031186 Dressing Forceps 8" (203mm)
- 031187 Dressing Forceps 10" (254mm)

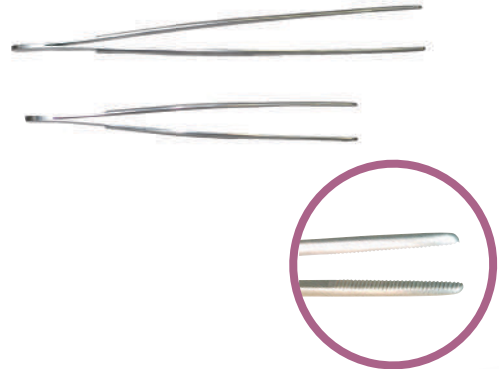

Fletcher Forceps

- 031014 Fletcher with Oval Jaws 9½" (241mm) Straight
- 031015 Fletcher with Oval Jaws 9½" (241mm) Curved



Straight

Curved

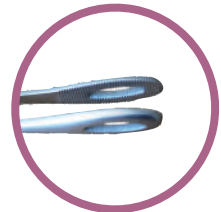
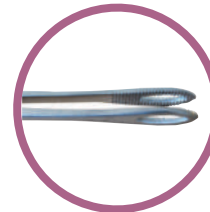

IUD Hooks

For IUD retrieval; available in single and double notch versions.

- 031306 IUD Hook 10" (254mm) Single Notch
- 031307 IUD Hook 10½" (265mm) Double Notch
- 031308 IUD Hook Universal 12½" (318mm)



Double

Single

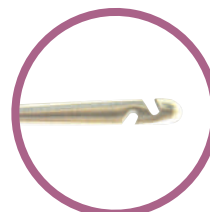

MedGyn Long-Reach Instruments

Allis Tissue Forceps

031099 Allis Forceps 12" (305mm) 5x6 Teeth

031100 Allis Forceps 14" (356mm) 5x6 Teeth

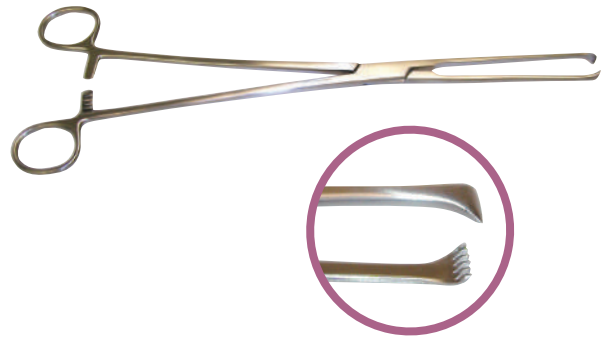

Babcock Tissue Forceps

031188 Babcock Tissue Forceps 12" (305mm)

031189 Babcock Tissue Forceps 14" (356mm)

031190 Babcock Tissue Forceps 18" (457mm)

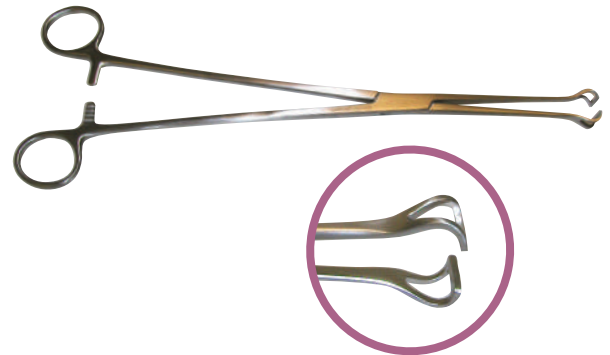

DeBakey Tissue Forceps

031182 DeBakey Tissue Forceps 12" (305mm)

031183 DeBakey Tissue Forceps 14" (356mm)

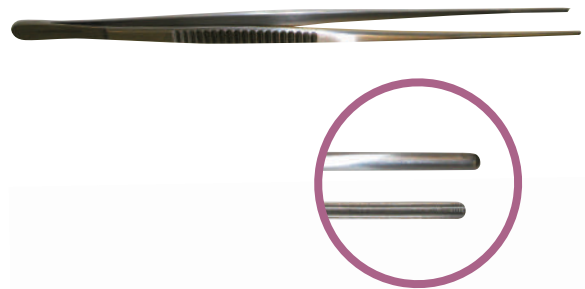

Gemini Forceps

031192 Gemini Forceps 14" (356mm) Curved



Crile Wood Needle Holder

040085 Crile Wood Needle Holder 12" (305mm)

040086 Crile Wood Needle Holder 14" (356mm)

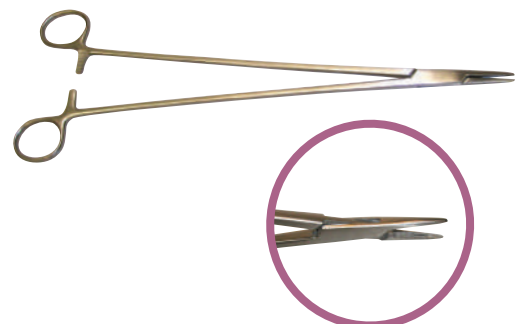

Rochester Ochsner Forceps

031184 Rochester Ochsner Forceps 12" (305mm)
Curved

031185 Rochester Ochsner Forceps 14" (356mm)
Curved

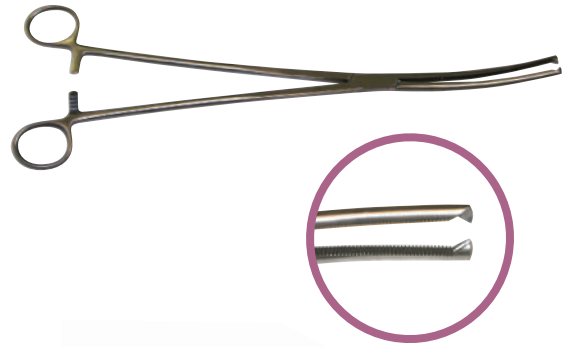

Clark Hysterectomy Forceps

031193 Clark Hysterectomy Forceps 12" (305mm)

031194 Clark Hysterectomy Forceps 14" (356mm)

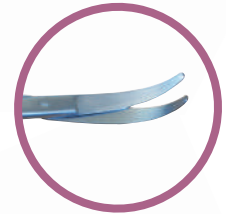

Kocher Forceps

031195 Kocher Forceps Curved 14" (356mm)



Jorgenson Scissors

031177 Jorgenson Scissors 14" (356mm) Curved



Metzenbaum Scissors

040091 Metzenbaum Scissors Curved 14"
(356mm)

040092 Metzenbaum Scissors Straight 14"
(356mm)

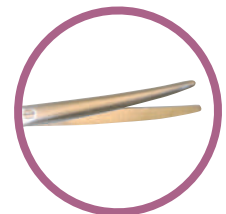

MedGyn Hysterectomy Clamps

Hysterectomy ("Z")- Clamps



Straight



Slight Curve



Strong Curve



Angled

- | | | | |
|--------|---|--------|---|
| 040025 | Hysterectomy Clamp 8¼" (210mm) - Straight | 040047 | Hysterectomy Clamp 12" (305mm) - Strong Curve |
| 040026 | Hysterectomy Clamp 8¼" (210mm) - Slight Curve | 040048 | Hysterectomy Clamp 12" (305mm) - Angled |
| 040027 | Hysterectomy Clamp 8¼" (210mm) - Full Curve | 040055 | Hysterectomy Clamp 14" (356mm) - Straight |
| 040028 | Hysterectomy Clamp 8¼" (210mm) - Angled | 040056 | Hysterectomy Clamp 14" (356mm) - Slight Curve |
| 040035 | Hysterectomy Clamp 9½" (241mm) - Straight | 040057 | Hysterectomy Clamp 14" (356mm) - Strong Curve |
| 040036 | Hysterectomy Clamp 9½" (241mm) - Slight Curve | 040058 | Hysterectomy Clamp 14" (356mm) - Angled |
| 040037 | Hysterectomy Clamp 9½" (241mm) - Strong Curve | 040015 | Hysterectomy Clamp 16" (406mm) - Straight |
| 040038 | Hysterectomy Clamp 9½" (241mm) - Angled | 040016 | Hysterectomy Clamp 16" (406mm) - Slight Curve |
| 040045 | Hysterectomy Clamp 12" (305mm) - Straight | 040017 | Hysterectomy Clamp 16" (406mm) - Strong Curve |
| 040046 | Hysterectomy Clamp 12" (305mm) - Slight Curve | 040018 | Hysterectomy Clamp 16" (406mm) - Angled |

MedGyn Hysterectomy Forceps

Peau Hysterectomy Forceps - Straight



030999 Peau Hysterectomy Forceps Straight 8" (203mm)

Peau Hysterectomy Forceps - Curved



031000 Peau Hysterectomy Forceps Curved 8" (203mm)

MedGyn Hysterectomy Scissors

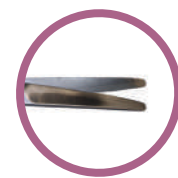

- | | | | |
|--------|---|--------|--|
| 041125 | Hysterectomy Scissors 9" (229mm) - Slight Curve | 041145 | Hysterectomy Scissors 12" (305mm) - Slight Curve |
| 041126 | Hysterectomy Scissors 9" (229mm) - Curve | 041146 | Hysterectomy Scissors 12" (305mm) - Curve |
| 041127 | Hysterectomy Scissors 9" (229mm) - Full Curve | 041147 | Hysterectomy Scissors 12" (305mm) - Full Curve |
| 041128 | Hysterectomy Scissors 9" (229mm) - Angled | 041148 | Hysterectomy Scissors 12" (305mm) - Angled |
| 041135 | Hysterectomy Scissors 10½" (267mm) - Slight Curve | 041155 | Hysterectomy Scissors 14" (356mm) - Slight Curve |
| 041136 | Hysterectomy Scissors 10½" (267mm) - Curve | 041156 | Hysterectomy Scissors 14" (356mm) - Curve |
| 041137 | Hysterectomy Scissors 10½" (267mm) - Full Curve | 041157 | Hysterectomy Scissors 14" (356mm) - Full Curve |
| 041138 | Hysterectomy Scissors 10½" (267mm) - Angled | 041158 | Hysterectomy Scissors 14" (356mm) - Angled |

MedGyn Scissors

Metzenbaum Scissors - Straight



- 041026 Metzenbaum 5" (127mm) - Standard Straight
- 041028 Metzenbaum 6" (152mm) - Standard Straight
- 041030 Metzenbaum 7" (178mm) - Standard Straight
- 041032 Metzenbaum 8" (203mm) - Standard Straight
- 041034 Metzenbaum 9" (229mm) - Standard Straight
- 041036 Metzenbaum 10" (254mm) - Standard Straight
- 041038 Metzenbaum 11" (279mm) - Standard Straight
- 041040 Metzenbaum 12" (305mm) - Standard Straight
- 041026-DEL Metzenbaum 5" (127mm) - Delicate Straight
- 041028-DEL Metzenbaum 6" (152mm) - Delicate Straight
- 041030-DEL Metzenbaum 7" (178mm) - Delicate Straight
- 041032-DEL Metzenbaum 8" (203mm) - Delicate Straight
- 041034-DEL Metzenbaum 9" (229mm) - Delicate Straight

Metzenbaum Scissors - Curved



- 041025 Metzenbaum 5" (127mm) - Standard Curved
- 041027 Metzenbaum 6" (152mm) - Standard Curved
- 041029 Metzenbaum 7" (178mm) - Standard Curved
- 041031 Metzenbaum 8" (203mm) - Standard Curved
- 041033 Metzenbaum 9" (229mm) - Standard Curved
- 041035 Metzenbaum 10" (254mm) - Standard Curved
- 041037 Metzenbaum 11" (279mm) - Standard Curved
- 041039 Metzenbaum 12" (305mm) - Standard Curved
- 041025-DEL Metzenbaum 5" (127mm) - Delicate Curved
- 041027-DEL Metzenbaum 6" (152mm) - Delicate Curved
- 041029-DEL Metzenbaum 7" (178mm) - Delicate Curved
- 041031-DEL Metzenbaum 8" (203mm) - Delicate Curved
- 041033-DEL Metzenbaum 9" (229mm) - Delicate Curved

Operating Scissors - Straight



- 042000-S Straight Scissors 4½" (114mm) - Blunt/Blunt
- 042001-S Straight Scissors 4½" (114mm) - Sharp/Blunt
- 042002-S Straight Scissors 4½" (114mm) - Sharp/Sharp
- 042004-S Straight Scissors 5" (127mm) - Blunt/Blunt
- 042003-S Straight Scissors 5" (127mm) - Sharp/Blunt
- 042005-S Straight Scissors 5" (127mm) - Sharp/Sharp
- 042006-S Straight Scissors 5½" (140mm) - Blunt/Blunt
- 042007-S Straight Scissors 5½" (140mm) - Sharp/Blunt
- 042008-S Straight Scissors 5½" (140mm) - Sharp/Sharp
- 042009-S Straight Scissors 6" (152mm) - Blunt/Blunt
- 042010-S Straight Scissors 6" (152mm) - Sharp/Blunt
- 042011-S Straight Scissors 6" (152mm) - Sharp/Sharp
- 042012-S Straight Scissors 6½" (165mm) - Blunt/Blunt
- 042013-S Straight Scissors 6½" (165mm) - Sharp/Blunt
- 042014-S Straight Scissors 6½" (165mm) - Sharp/Sharp
- 042015-S Straight Scissors 7½" (191mm) - Sharp/Blunt
- 042016-S Straight Scissors 7½" (191mm) - Blunt/Blunt

Operating Scissors - Curved



- 042000-C Curved Scissors 4½" (114mm) - Blunt/Blunt
- 042001-C Curved Scissors 4½" (114mm) - Sharp/Blunt
- 042002-C Curved Scissors 4½" (114mm) - Sharp/Sharp
- 042004-C Curved Scissors 5" (127mm) - Blunt/Blunt
- 042003-C Curved Scissors 5" (127mm) - Sharp/Blunt
- 042005-C Curved Scissors 5" (127mm) - Sharp/Sharp
- 042006-C Curved Scissors 5½" (140mm) - Blunt/Blunt
- 042007-C Curved Scissors 5½" (140mm) - Sharp/Blunt
- 042008-C Curved Scissors 5½" (140mm) - Sharp/Sharp
- 042009-C Curved Scissors 6" (152mm) - Blunt/Blunt
- 042010-C Curved Scissors 6" (152mm) - Sharp/Blunt
- 042011-C Curved Scissors 6" (152mm) - Sharp/Sharp
- 042012-C Curved Scissors 6½" (165mm) - Blunt/Blunt
- 042013-C Curved Scissors 6½" (165mm) - Sharp/Blunt
- 042014-C Curved Scissors 6½" (165mm) - Sharp/Sharp
- 042015-C Curved Scissors 7½" (191mm) - Sharp/Blunt

Doyen Scissors

- 041075 Doyen Scissors 7" (178mm) - Curved/Smooth
- 041076 Doyen Scissors 7" (178mm) - Straight/Smooth
- 041077 Doyen Scissors 7" (178mm) - Curved/Serrated
- 041078 Doyen Scissors 7" (178mm)- Straight/Serrated



IUD Scissors

- 041010 IUD Scissors Curved 10" (254mm)



Mayo Scissors

- 041061 Straight Mayo Scissors 5½" (140mm)
- 041063 Straight Mayo Scissors 6¾" (171mm)
- 041070 Straight Mayo Scissor 8" (203mm)
- 041067 Straight Mayo Scissors 9" (229mm)
- 041071 Straight Mayo Scissor 10¼"(260mm)
- 041069 Straight Mayo Scissors 11" (279mm)
- 041060 Curved Mayo Scissors 5½" (140mm)
- 041062 Curved Mayo Scissors 6¾" (171mm)
- 041064 Curved Mayo Scissors 8" (203mm)
- 041066 Curved Mayo Scissors 9" (229mm)
- 041068 Curved Mayo Scissors 11" (279mm)

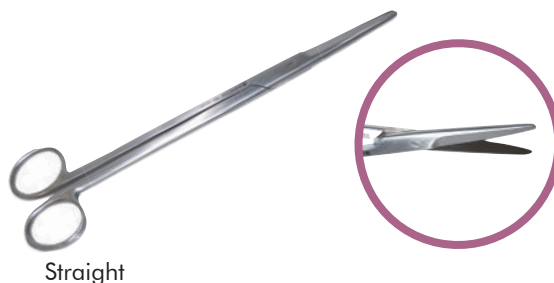

Straight



Curved

Iris Scissors

- 041100 Iris Scissors 3½" (89mm), 20mm Blades Delicate Curved
- 041101 Iris Scissors 3½" (89mm), 20mm Blades Delicate Straight
- 041102 Iris Scissors 3¾" (95mm), 14mm Blades Curved Ribbon Type
- 041103 Iris Scissors 3¾" (95mm), 14mm Blades Straight Ribbon Type
- 041104 Iris Scissors 4½" (114mm) Angled on Side
- 041105 Iris Scissors 4½" (114mm) Curved
- 041106 Iris Scissors 4½" (114mm) Curved Sideways
- 041107 Iris Scissors 4½" (114mm) Straight



Kelly-Adson Scissors

- 041085 Kelly-Adson 6¼" (159mm) Smooth/Straight
- 041086 Kelly-Adson 6¼" (159mm) Serrated/Straight
- 041087 Kelly-Adson 6¼" (159mm) Smooth/Curved

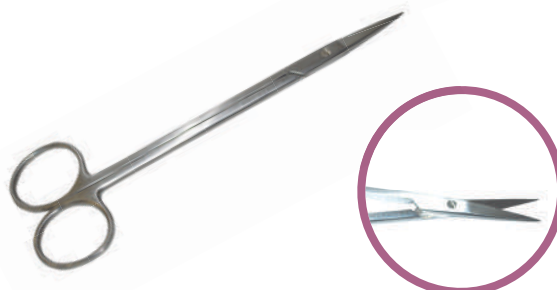

Potts-Smith Scissors

- 041015 Potts-Smith Scissors 7" (178mm), 13mm Blades, Delicate - Angled 25°
- 041016 Potts-Smith Scissors 7" (178mm), 13mm Blades, Delicate - Angled 45°
- 041017 Potts-Smith Scissors 7" (178mm), 13mm Blades, Delicate - Angled 60°
- 041018 Potts-Smith Scissors 7½" (191mm), 20mm Blades, Delicate - Angled 25°
- 041019 Potts-Smith Scissors 7½" (191mm), 20mm Blades, Delicate - Angled 45°
- 041020 Potts-Smith Scissors 7½" (191mm), 20mm Blades, Delicate - Angled 60°

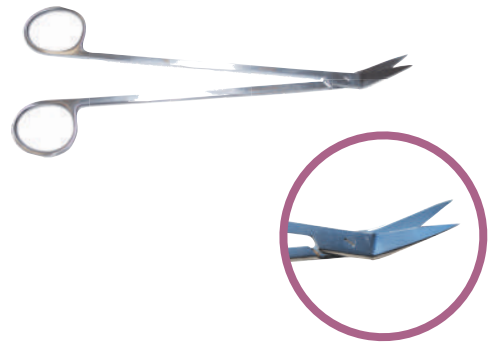

Lister Scissors

- 041050 Lister Bandage Scissors 3½" (89mm) Extra Fine
- 041051 Lister Bandage Scissors 4½" (114mm) Extra Fine
- 041052 Lister Bandage Scissors 5½" (140mm) Extra Fine
- 041053 Lister Bandage Scissors 7¼" (184mm) Extra Fine
- 041054 Lister Bandage Scissors 8" (203mm) with One Larger Finger Ring



Littauer Scissors

- 041088 Littauer Stitch Scissors 4½" (114mm) Light
- 041089 Littauer Stitch Scissors 5½" (140mm) Standard
- 042099-ECO Littauer Stitch Scissor 4½" (114mm) Economy



Sweet Stitch Scissors

- 041096 Sweet Stitch Scissors 8½" (216mm) Angled on Flat

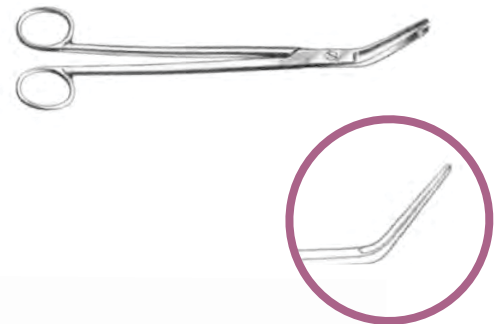

Spencer Scissors

- 041095 Spencer Stitch Scissors 3½" (89mm) Delicate



MedGyn Needle Holders

Webster Needle Holder

- 040075 Webster Needle Holder 5" (127mm) Serrated Jaws
- 040076 Webster Needle Holder 5" (127mm) Smooth Jaws

Mayo-Hegar Needle Holder

- 040093 Mayo-Hegar Needle Holder 5" (127mm) Serrated
- 040094 Mayo-Hegar Needle Holder 6" (152mm) Serrated
- 040095 Mayo-Hegar Needle Holder 7" (178mm) Serrated
- 040096 Mayo-Hegar Needle Holder 8" (203mm) Serrated

Olsen-Hegar Needle Holder/Scissors

- 040097 Olsen-Hegar Needle Holder/Scissors 4³/₄" (121mm) Serrated Extra Delicate
- 040098 Olsen-Hegar Needle Holder/Scissors 4³/₄" (121mm) Smooth Extra Delicate
- 040099 Olsen-Hegar Needle Holder/Scissors 5¹/₂" (140mm) Serrated
- 040100 Olsen-Hegar Needle Holder/Scissors 6¹/₂" (165mm) Serrated
- 040101 Olsen-Hegar Needle Holder/Scissors 7¹/₄" (184mm) Serrated

Heaney Needle Holder

- 040071 Heaney Needle Holder 8¹/₂" (216mm) Curved Jaws

Mathieu Needle Holder

- 040072 Mathieu Needle Holder 5¹/₂" (140mm) w/Spring Handles
- 040073 Mathieu Needle Holder 6¹/₄" (159mm) w/Spring Handles
- 040074 Mathieu Needle Holder 7¹/₂" (191mm) w/Spring Handles

Crile-Wood Needle Holder

- 040081 Crile-Wood Needle Holder 6" (152mm)
- 040082 Crile-Wood Needle Holder 7" (178mm)
- 040083 Crile-Wood Needle Holder 8" (203mm)
- 040084 Crile-Wood Needle Holder 9" (229mm)
- 040087 Crile-Wood Needle Holder 10¹/₂" (267mm)

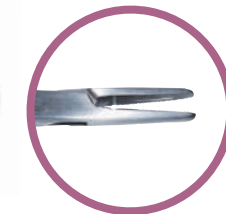
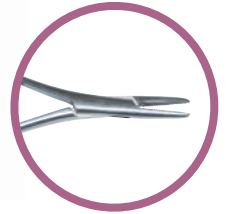

MedGyn Needle Extender Adapters

Needle Adapters

An effective means of extending ordinary hypodermic needles when longer needles are required. The paracervical and uterosacral areas can easily be reached with an extended needle

- 030501 Needle Adapter 3" (76mm)
- 030502 Needle Adapter 4" (102mm)
- 030503 Needle Adapter 5" (127mm)
- 030504 Needle Adapter 6" (152mm)



030504

Endotracheal Tube Holder

Disposable and ready to use, the Endotracheal Tube Holder secures tubes used with ventilators and other breathing assistance devices.

- Does not contain natural rubber latex
- No tape is required to place the ET Tube Holder
- May eliminate need for a bite block
- Wide cotton-lined neckband minimizes skin irritation, providing maximum patient comfort

TMI-ET1 Endotracheal Tube Holder



Miscellaneous Products

- 040004 Emesis Basin Medium 8" (203mm)
- 040005 Emesis Basin Large 10" (254mm)
- 040003 Emesis Basin Small 6" (152mm)
- 040008 Iodine Cup 6oz
- 040001 Medicine Cup (2 oz.)
- 040009 Instrument Cleaner 8oz Bottle
- 040000 Instrument Lubricant Spray - 8oz
- 040010 Instrument Stain Remover 3oz
- 040002 Instrument Steel Tray - 12¼" X 7⅝" X 2⅛"
(Graham 3259)



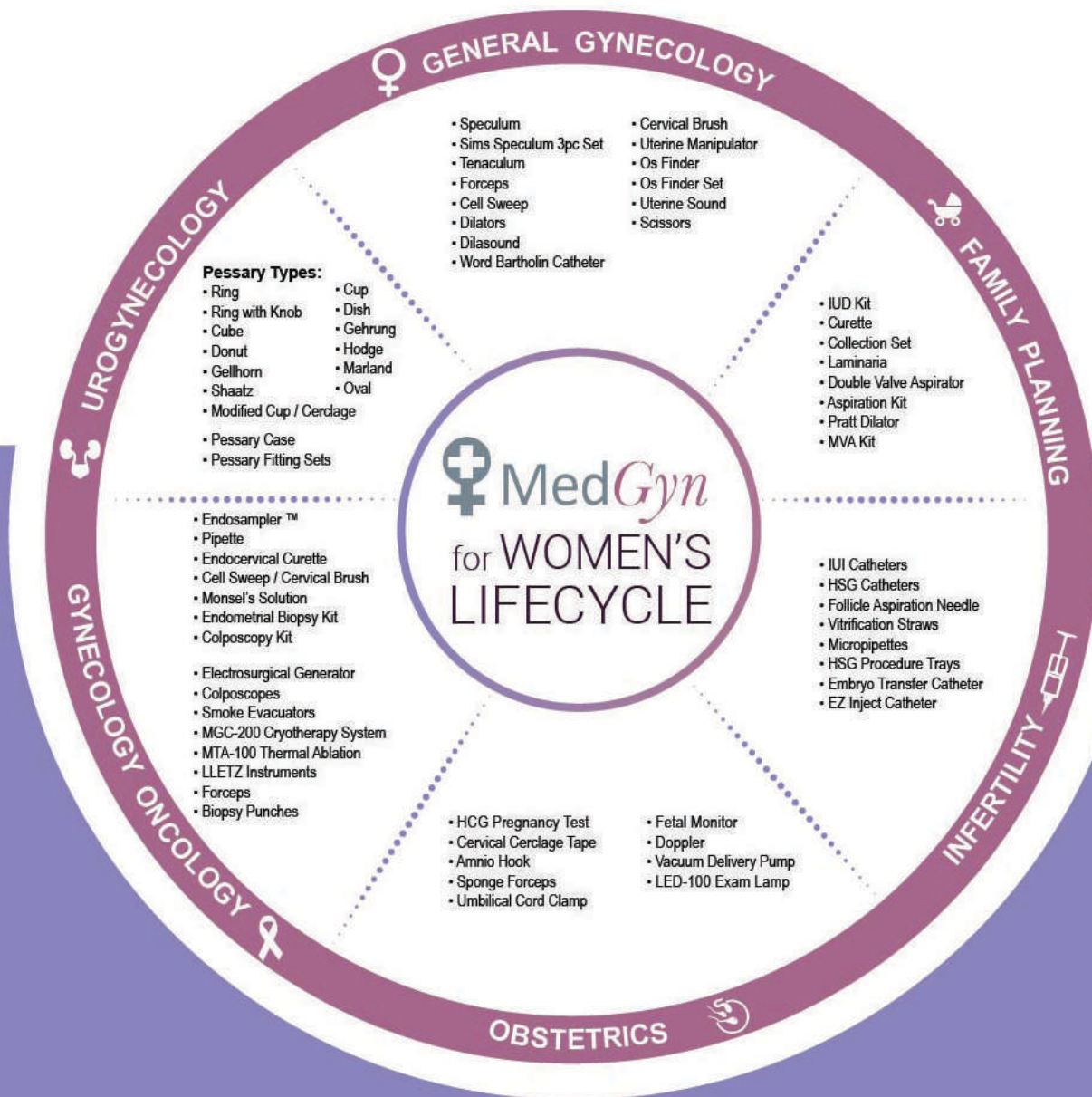

PHONE

Main: 1.630.627.4105
Toll-Free: 1.800.451.9667
Fax: 1.630.627.0127

ADDRESS

800 Pasquinelli Dr.
Westmont, IL 60559
USA

WEBSITE

medgyn.com

EMAIL

info@medgyn.com

